

# TOP DEAL

**KS TOOLS**

WWW.KSTOOLS.COM

*No Limits!*

UNSERE SCHLÜSSELKOMPETENZ:

**QUALITÄT ZUM HAMMER-PREIS!**

EVOLUTION  
SERIES



Komplette  
Stückliste

917.0255

1/4" + 3/8" + 1/2" + 5/16"

255 TEILE  
FÜR NUR

**119,90**



**P10**

**i** 397  
Weitere Informationen

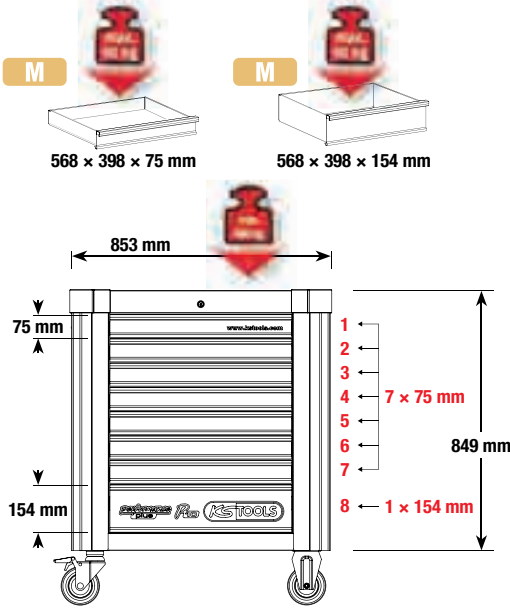

Integrierter Kantenschutz

**WÄHLEN SIE IHR POWER-PAKET**

810.7397

inklusive Papierrollenhalter	inklusive Dosenhalter	Stabile Kugellager	Antistatische Rollen mit Bremse	

**i** 397  
Weitere Informationen

**P15**

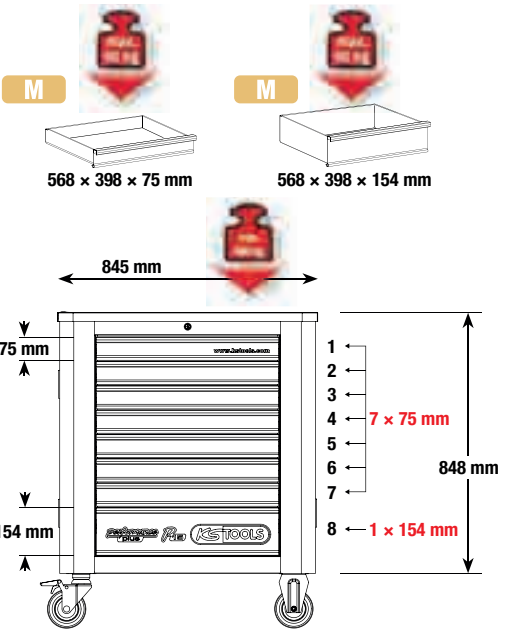

815.7397

**DAS PERFEKTE PAKET MIT 397 TEILEN**



41

Schraubendreher-Satz



41

Schraubenschlüssel-Satz

**2699,00**

810.7397 P10 Werkstattwagen mit 397 Werkzeugen



111

1/4" + 3/8" + 1/2" Steckschlüssel-Satz



28

Zangen- und Feilen-Satz

**2799,00**

815.7397 P15 Werkstattwagen mit 397 Werkzeugen



111

1/2" Bit-Stecknuss-Satz



43

Öl- und Reifendienst-Satz



22

Hammer- und Meißel-Satz

# HERZLICH WILLKOMMEN IN



564



Weitere Informationen



**MIT 564 WERKZEUGEN**

**3799,00**



Integrierter Kantenschutz



inklusive Dosenhalter



Stabile Kugellager



Antistatische Rollen mit Bremse



Schloss

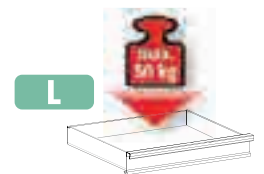
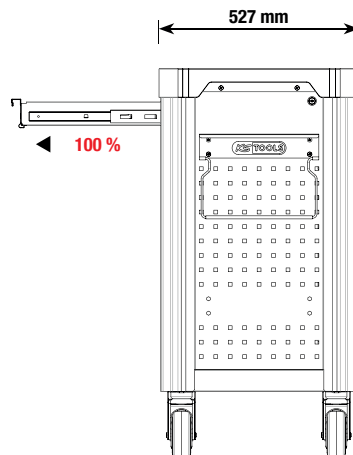
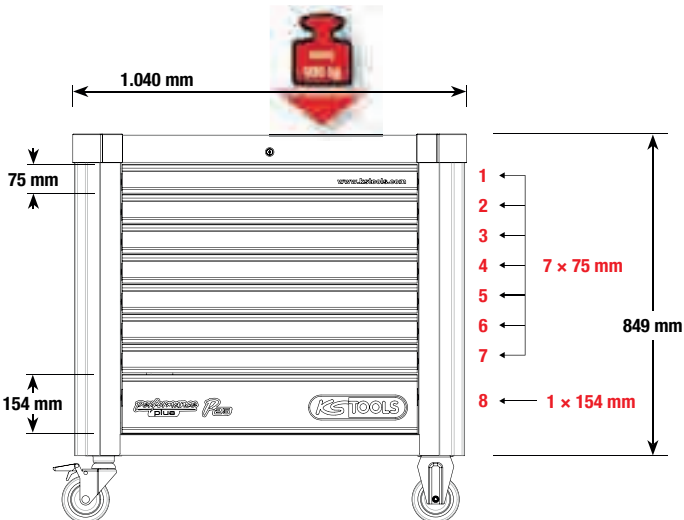

755 x 398 x 75 mm

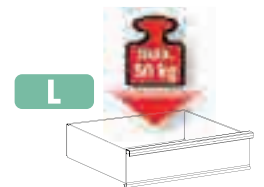

755 x 398 x 154 mm

825.8564

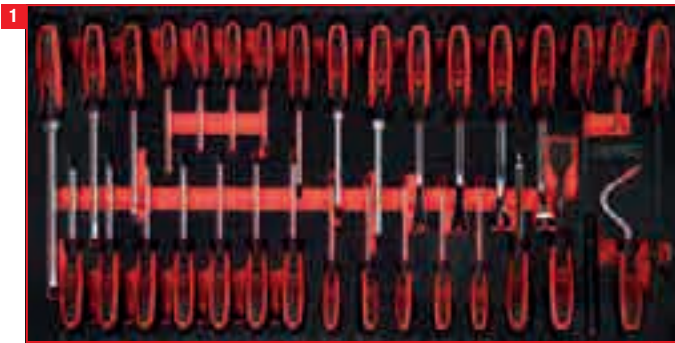

Schraubendreher-Satz

33



1/4" + 3/8" Steckschlüssel-Satz

213



1/2" Steckschlüssel-Satz

86



Schraubenschlüssel-Satz

57



Schraubenschlüssel-Satz

54



Schraubendreher- und Feilen-Satz

42



Zangen- und Messwerkzeug-Satz

39



Hammer- Meißel- und Kraft-Stecknuss-Satz

40

# WIE VIEL WAGEN DARF'S SEIN?



Arbeitsplatte mit 10 mm starker Schaumstoffeinlage



verschießbar durch eingebautes Zylinderschloss



mit Selbstenzug und SOFT-CLOSE-Funktion



Vierkantlochung für Zubehörteile



2 x Roll- und Drehbremsen Ø Räder: 125 mm

## ECO Line

# 449,90

**OHNE WERKZEUGE**

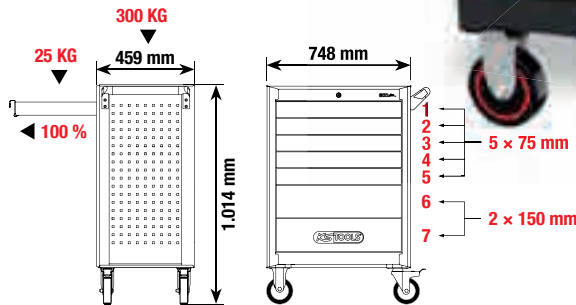

**i** **1** 897.0007

Weitere Informationen

Technische Daten:	Eco Line 897.0007	Racing Line 826.0007
Gesamttragkraft:	300,0 kg	350,0 kg
Belastbarkeit je Schublade:	25,0 kg	30,0 kg
Selbstenzug und SOFT-CLOSE-Funktion:	✓	✗
Raddurchmesser:	125,0 mm	125,0 mm
Radfeststeller:	✓	✓
Mit Zentralverriegelung:	✓	✓
Einzelverriegelung Schubladen:	✗	✓
Höhe:	1014,0 mm	976,0 mm
Breite:	748 mm	788 mm
Tiefe:	459,0 mm	496,0 mm
Schubladeninnenmaß:	565 x 395 mm	565 x 395 mm
mit Polyurethan Ecken-Kantenschutz:	✗	✓
Vierkantlochung für Zubehörteile:	✓	✓
Anzahl Schubladen:	7	7
Blechstärke:	0,8 mm	0,9 mm
Griffleisten:	✓	✓
Schubladenauszug:	100 %	90 %
Arbeitsplatte mit Kleinteilfächern:	✗	✓
Arbeitsplatte mit Schaumstoffeinlagen:	✓	✗
kugelgelagerte Schubladenführung:	✓	✓
seitlicher Metallhandgriff:	✓	✓

## QUAL DER WAHL? WAHL MIT QUALITÄT!

## RACING Line



Arbeitsplatte aus ABS mit Kleinteilfächern



verschießbar durch eingebautes Zylinderschloss



Einzelverriegelung verhindert ungewolltes Öffnen



Vierkantlochung für Zubehörteile



2 x Roll- und Drehbremsen Ø Räder: 125 mm

# 499,90

**OHNE WERKZEUGE**

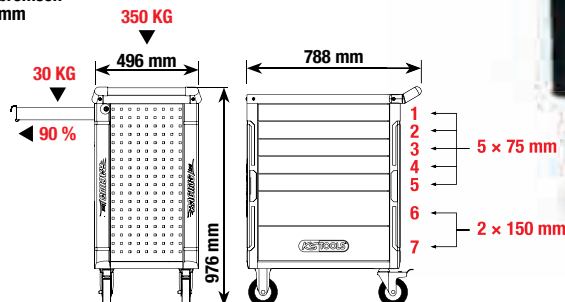

**i** **1** 826.0007

Weitere Informationen

**ECO** *line*

Mit 7 Schubladen und  
215 Premium-Werkzeugen

**679,90**

897.7215



# START PAKET - 215 TLG.



**RACING** *line*

Mit 7 Schubladen und  
215 Premium-Werkzeugen

**699,90**

826.7215

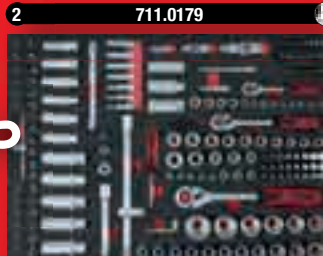

**ECO** *line*

Mit 7 Schubladen und  
515 Premium-Werkzeugen

**879,90**

897.7515



# UNIVERSAL PAKET - 515 TLG.

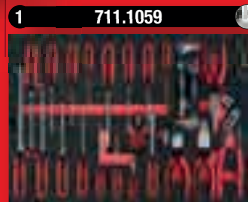

**RACING** *line*

Mit 7 Schubladen und  
515 Premium-Werkzeugen

**899,90**

826.7515

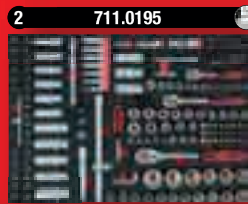

**ECO** *line*

Mit 7 Schubladen und  
598 Premium-Werkzeugen

**1299,00**

897.7598

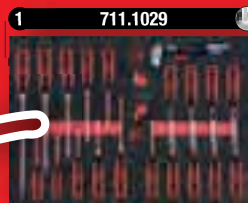

# POWER PAKET - 598 TLG.

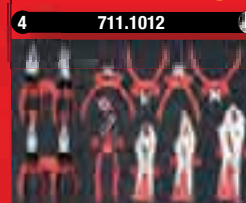

**RACING** *line*

Mit 7 Schubladen und  
598 Premium-Werkzeugen

**1349,00**

826.7598

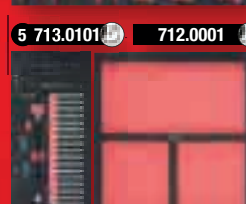
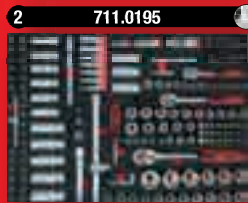

- DIN 3110 / ISO 1085 / ISO 10102 / ISO 3318
- Maulstellung 15° abgewinkelt
- geschliffene Köpfe
- matt satiniert
- Chrom Vanadium

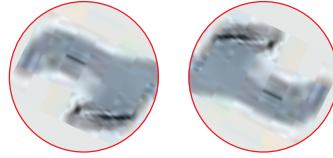

**ab 19,90**

<b>A</b>	517.0148			6x7 · 8x9 · 10x11 · 12x13 14x15 · 16x17 · 18x19 20x22 mm	19,90 €
<b>B</b>	517.0123			6x7 · 8x9 · 10x11 · 12x13 14x15 · 16x17 · 18x19 20x22 · 21x23 · 24x27 30x32 mm	44,90 €
<b>C</b>	517.0125			6x7 · 8x9 · 10x11 · 12x13 14x15 · 16x17 · 18x19 20x22 · 21x23 · 24x27 25x28 · 30x32 mm	49,90 €



- FlankTraction-Profil
- Maulstellung 15° abgewinkelt
- Ring 15° abgewinkelt
- polierte Köpfe
- matt satiniert



**ab 22,90**

<b>A</b>	517.0048			8 · 9 · 10 · 11 · 13 · 14 17 · 19 mm	22,90 €
<b>B</b>	517.0052			8 · 9 · 10 · 11 · 12 · 13 · 14 15 · 16 · 17 · 18 · 19 mm	42,90 €
<b>C</b>	517.0043			6 · 7 · 8 · 9 · 10 · 11 · 12 13 · 14 · 15 · 16 · 17 · 18 19 · 20 · 21 · 22 · 24 · 27 30 · 32 mm	109,50 €



- 12-kant
- DIN 838 / ISO 1085 / ISO 10104 / ISO 3318
- Ringe 75° gekröpft
- dünnwandig
- polierte Köpfe



**ab 24,90**

<b>A</b>	517.0248			6x7 · 8x9 · 10x11 · 12x13 14x15 · 16x17 · 18x19 20x22 mm	24,90 €
<b>B</b>	517.0222			6x7 · 8x9 · 10x11 · 12x13 14x15 · 16x17 · 18x19 20x22 · 21x23 · 24x27 30x32 mm	49,90 €





**i** **1**  
Weitere Informationen

**14,90**

315 mm

L R

22 mm

19 mm

522.1922

**i** **1**  
Weitere Informationen

**DIE 4 IN 1 WENDERATSCHKE**

10 mm

13 mm

17 mm

19 mm

**19,90**

72  $\times$  5°

L R

503.4565 10 x 13 x 17 x 19 mm

**i** **1**  
Weitere Informationen

**DAS MULTITALENT**

Einhand-Multifunktions-Schlüssel

260 mm

8 - 17 mm

14 - 32 mm

1 2 3

**33,90**

114.0055 8 · 9 · 10 · 11 · 12 · 13 · 14 · 15 · 16 · 17 · 18 · 19 · 20 · 21 · 22 · 23 · 24 · 25 · 26 · 27 · 28 · 29 · 30 · 31 · 32 mm

**i** **12**  
Weitere Informationen

72  $\times$  5°

**119,90**

L R

503.4665 8 - 9 - 10 - 11 - 12 - 13 - 14 - 15 - 16 - 17 - 18 - 19 mm

**i** **30**  
Weitere Informationen

**DER ALLESKÖNNER**

5/16" x 13 mm

1/2"

10 mm x 13 mm

3/8"

1/4" x 10 mm

1/4"

12 x

12 x

**168,90**

503.4960 8 - 9 - 10 - 11 - 12 - 13 - 14 - 15 - 16 - 17 - 18 - 19 mm

**i** **2**  
Weitere Informationen

72 5°

1/2" 305 - 445 mm

1/4" 173 - 223 mm

**NEU**

**34,90**

**VERSTELLBAR:**  
1/4" IN 4 STUFEN  
1/2" IN 6 STUFEN

914.1412

**i** **1**  
Weitere Informationen

**NEU**

600 MM!

72 5°

1/2" 460 - 600 mm

Stufe: 1 2 3 4 5 6

**24,90**

**VERSTELLBAR IN 6 STUFEN**

914.1205

**i** **1**  
Weitere Informationen

**49,90**

760 mm

1/2"

**MAXIMALE FLEXIBILITÄT,  
OPTIMALE KONTROLLE**

918.1293

**72 5°**

**BESTÄNDIGE POWER -  
INNOVATIVE FUNKTION**

A B C

1/4" 3/8" 1/2"

**ab 24,90**

			Nm	↔	
<b>A</b>	920.1490		1/4"	102	140 mm 24,90 €
<b>B</b>	920.3890		3/8"	325	190 mm 29,90 €
<b>C</b>	920.1290		1/2"	710	245 mm 36,50 €

**102 Nm**

**710 Nm**

**72 5°**

**54,90**

**920.0002** **i** **2**  
Weitere Informationen

# DIE BESTEN, DIE WIR JE GEBAUT HABEN!

Wir wissen, was wir können. Und weil wir ganz genau wissen, wie gut unser neues Monster-Ratschen-Sortiment ist, ist es für uns selbstverständlich, Ihnen eine Garantie auf jedes Modell zu gewähren. Nicht 2 oder 3 Jahre. Nein, es sind gleich 10 Jahre! Damit die Garantie genauso Premium ist wie unsere Monster-Ratschen!



**1** **80**  $\times$   $4,5^\circ$   
**1/4"** **29,90** **i** **1**  
Weitere Informationen

935.1490 **1/4"** **106 g** **125 mm** **>110 Nm**

**2** **80**  $\times$   $4,5^\circ$   
**1/4"** **29,90** **i** **1**  
Weitere Informationen

935.1495 **1/4"** **106 g** **125 mm** **>100 Nm**

**3** **96**  $\times$   $3,75^\circ$   
**3/8"** **39,90** **i** **1**  
Weitere Informationen

935.3890 **3/8"** **227 g** **199 mm** **>365 Nm**

**i**

**GARANTIERT:  
6 MONSTER  
FÜRS LEBEN!**

**i**

**4** **100**  $\times$   $3,6^\circ$   
**1/2"** **49,90** **i** **1**  
Weitere Informationen

935.1290 **1/2"** **567 g** **275 mm** **>950 Nm**

**i**

**5** **100**  $\times$   $3,6^\circ$   
**1/2"** **69,90** **i** **1**  
Weitere Informationen

935.1295 **1/2"** **757 g** **425 mm** **>950 Nm**

**i**

**6** **100**  $\times$   $3,6^\circ$   
**1/2"** **99,90** **i** **1**  
Weitere Informationen

**TELESKOPIERBAR**

406 431 457 482 508 533 557 582 607 635 mm

935.1285 **1/2"** **1.280 g** **406 - 635 mm** **>950 Nm**

**i**

**NEU**

935.0002

**100**  $\times$   $3,6^\circ$   
**1/2"** **>950 Nm**

**80**  $\times$   $4,5^\circ$  **1/4"** **>110 Nm**

**+**

**i** **2**  
Weitere Informationen

**69,90**

Alle Preise in EUR zzgl. MwSt. gelten bis 30.09.2024

**i**  **9**  
 Weitere Informationen

**Bit-Stecknuss-Satz  
 für Innensechskant-Schrauben, kurz**

**3/8"** 

4 mm 5 mm 6 mm 7 mm 8 mm 9 mm 10 mm 12 mm 14 mm

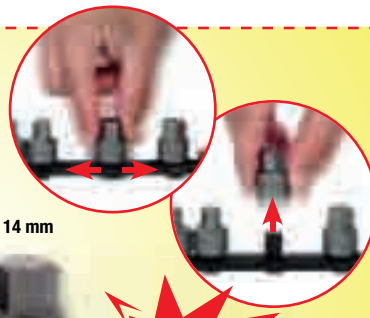

**NEU**

**34,90**

917.4000  4 - 5 - 6 - 7 - 8 - 9 - 10 - 12 - 14 mm

**BITTE EIN BIT. ABER KURZ!**

**i**  **10**  
 Weitere Informationen

**Bit-Stecknuss-Satz  
 für Torx-Schrauben, kurz**

**3/8"** 

T10 T15 T20 T25 T27 T30 T40 T45 T50 T55

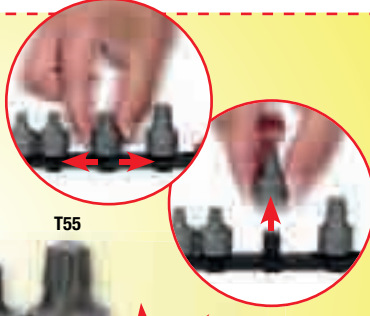



















**NEU**







**39,90**

917.4015  T10 - T15 - T20 - T25 - T27 - T30 - T40 - T45 - T50 - T55

**TORX TOTAL: ALLES IN EINEM KOFFER**

**i**  **77**  
 Weitere Informationen

5 x		1/4": E4 - E5 - E6 - E7 - E8
4 x		3/8": E10 - E12 - E14 - E16
4 x		1/2": E18 - E20 - E22 - E24
5 x		1/4": EPL4 - EPL5 - EPL6 - EPL7 - EPL8
4 x		3/8": EPL10 - EPL12 - EPL14 - EPL16
4 x		1/2": EPL18 - EPL20 - EPL22 - EPL24
8 x		1/4": T6 - T8 - T10 - T15 - T20 - T25 - T27 - T30
5 x		3/8": T40 - T45 - T47 - T50 - T55
2 x		1/2": T60 - T70
7 x		1/4": TB8 - TB10 - TB15 - TB20 - TB25 - TB27 - TB30
4 x		3/8": TB40 - TB45 - T50 - T55
1 x		1/2": TB60
7 x		1/4": IP8 - IP10 - IP15 - IP20 - IP25 - IP27 - IP30
3 x		3/8": IP40 - IP45 - IP50
2 x		1/2": IP55 - IP60
7 x		1/4": IPR8 - IPR10 - IPR15 - IPR20 - IPR25 - IPR27 - IPR30
3 x		3/8": IPR40 - IPR45 - IPR50
2 x		1/2": IPR55 - IPR60

-  E ✓
-  EPL ✓
-  TX ✓
-  TB ✓
-  IP ✓
-  IPR ✓

**99,90**

**NEU**



EVOLUTION  
 SERIES

**1/4" + 3/8" + 1/2"**

911.0077

**i** **30**  
Weitere Informationen

EVOLUTION SERIES

**NEU**

**79,90**



55 mm	●	5 - 6 - 7 - 8 - 10 - 12 - 14 - 17 - 19 mm
100 mm	●	5 - 6 - 7 - 8 - 10 - 11 - 12 - 13 mm
140 mm	●	5 - 6 - 7 - 8 - 10 - 12 - 14 mm
200 mm	●	5 - 6 - 7 - 8 - 10 - 12 mm

**1/2"** 

911.4510

**i** **32**  
Weitere Informationen

EVOLUTION SERIES

**NEU**

**79,90**



55 mm	★	M5 - M6 - M7 - M8 - M9 - M10 - M12 - M13 - M14
100 mm	★	M5 - M6 - M7 - M8 - M9 - M10 - M12 - M13 - M14
140 mm	★	M7 - M8 - M9 - M10 - M12 - M13 - M14
200 mm	★	M7 - M8 - M9 - M10 - M12 - M13 - M14

**1/2"** 

911.4520

**i** **26**  
Weitere Informationen

EVOLUTION SERIES

**NEU**

**79,90**



55 mm	●	M5 - M6 - M8 - M9 - M10 - M12 - M14 - M16
100 mm	●	M5 - M6 - M8 - M9 - M10 - M12 - M14
140 mm	●	M5 - M6 - M8 - M9 - M10 - M12 - M14
200 mm	●	M8 - M10 - M12 - M14

**1/2"** 

911.4540

**i** **32**  
Weitere Informationen

EVOLUTION SERIES

**NEU**

**79,90**



55 mm	★	T20 - T25 - T27 - T30 - T40 - T45 - T50 - T55 - T60 - T70
100 mm	★	T20 - T25 - T27 - T30 - T40 - T45 - T50 - T55 - T60 - T70
140 mm	★	T40 - T45 - T50 - T55 - T60 - T70
200 mm	★	T40 - T45 - T50 - T55 - T60 - T70

**1/2"** 

911.4550

**A** matt satiniert **B** hochglanz verchromt

**ab 27,90**

vernickelt

<b>A</b>	917.0648		48	27,90 €	1/4"
<b>B</b>	918.0648		48	29,90 €	 4 - 4,5 - 5 - 5,5 - 6 - 7 - 8 - 9 10 - 11 - 12 - 13 - 14 mm

**20**

Weitere Informationen

**59,90**

matt satiniert

1/2"

911.0620

10 - 11 - 12 - 13 - 14 - 15 - 16  
17 - 18 - 19 - 20 - 21 - 22 - 24  
27 - 30 - 32 mm

**A** matt satiniert **B** hochglanz verchromt

**ab 79,90**

vernickelt

<b>A</b>	911.0694		94	79,90 €	1/4" + 1/2"
<b>B</b>	918.0694		94	89,90 €	 4 - 4,5 - 5 - 5,5 - 6 - 7 - 8 - 9 10 - 11 - 12 - 13 - 14 - 15 - 16 17 - 18 - 19 - 20 - 21 - 22 - 23 24 - 27 - 30 - 32 mm

**108**

Weitere Informationen

**89,90**

matt satiniert

1/4" + 1/2"

911.0708

4 - 4,5 - 5 - 5,5 - 6 - 7 - 8 - 9  
10 - 11 - 12 - 13 - 14 - 15 - 16  
17 - 18 - 19 - 20 - 21 - 22 - 24  
27 - 30 - 32 mm

vernickelt



Weitere Informationen

1/4"	<ul style="list-style-type: none"> <li>4 - 4,5 - 5 - 5,5 - 6 - 7 - 8 - 9 - 10 - 11 - 12 - 13 - 14 mm</li> <li>4 - 5 - 6 - 7 - 8 - 9 - 10 mm</li> <li>E4 - E5 - E6 - E7 - E8</li> <li> </li> </ul>
3/8"	<ul style="list-style-type: none"> <li>10 - 11 - 12 - 13 - 14 - 15 - 16 - 17 - 18 - 19 mm</li> <li>10 - 11 - 12 - 13 - 14 - 15 mm</li> <li>E10 - E11 - E12 - E14 - E16 - E1</li> </ul>
1/2"	<ul style="list-style-type: none"> <li>10 - 11 - 12 - 13 - 14 - 15 - 16 - 17 - 18 - 19 - 20 - 21 - 22 - 24 - 27 - 30 - 32 mm</li> <li>16 - 17 - 18 - 19 - 22 mm</li> <li>E20 - E24</li> </ul>
1/4" 5/16"	<ul style="list-style-type: none"> <li> </li> </ul>
1/4" - 3/8" 1/2"	<ul style="list-style-type: none"> <li>50 - 100 - 125 - 150 - 250 mm</li> </ul>
1/4" - 3/8" 1/2"	<ul style="list-style-type: none"> <li>1,3 - 1,5 - 2 - 2,5 - 3 - 4 - 5 mm</li> </ul>
1/4" - 3/8" 1/2"	<ul style="list-style-type: none"> <li>1/4" - 5/16"</li> </ul>
1/4"	



1/4" + 3/8" + 1/2"

vernickelt

matt satiniert

94,90

917.0779

1/4"	<ul style="list-style-type: none"> <li>4 - 4,5 - 5 - 5,5 - 6 - 7 - 8 - 9 - 10 - 11 - 12 - 13 - 14 mm</li> <li>6 - 7 - 8 - 9 - 10 - 11 - 12 - 13 - 14 - 15 mm</li> <li> </li> </ul>
3/8"	<ul style="list-style-type: none"> <li>10 - 11 - 12 - 13 - 14 - 15 - 16 - 17 - 18 - 19 mm</li> <li>10 - 11 - 12 - 13 - 14 - 15 mm</li> </ul>
1/2"	<ul style="list-style-type: none"> <li>10 - 11 - 12 - 13 - 14 - 15 - 17 - 18 - 19 - 20 - 21 - 22 - 24 - 27 - 30 - 32 mm</li> <li>17 - 19 - 22 mm</li> <li> </li> </ul>
1/4" 5/16"	<ul style="list-style-type: none"> <li> </li> </ul>
12 x	<ul style="list-style-type: none"> <li>8 - 9 - 10 - 11 - 12 - 13 - 14 - 15 - 16 - 17 - 18 - 19 mm</li> </ul>
1/4" - 3/8" 1/2"	<ul style="list-style-type: none"> <li>1,3 - 1,5 - 2 - 2,5 - 3 - 4 - 5 mm</li> </ul>
1/4"	



A matt satiniert

B hochglanz verchromt

ab 174,90

A 917.0216 216 174,90 €

B 918.0216 216 189,90 €

1/4" + 3/8" + 1/2"

vernickelt

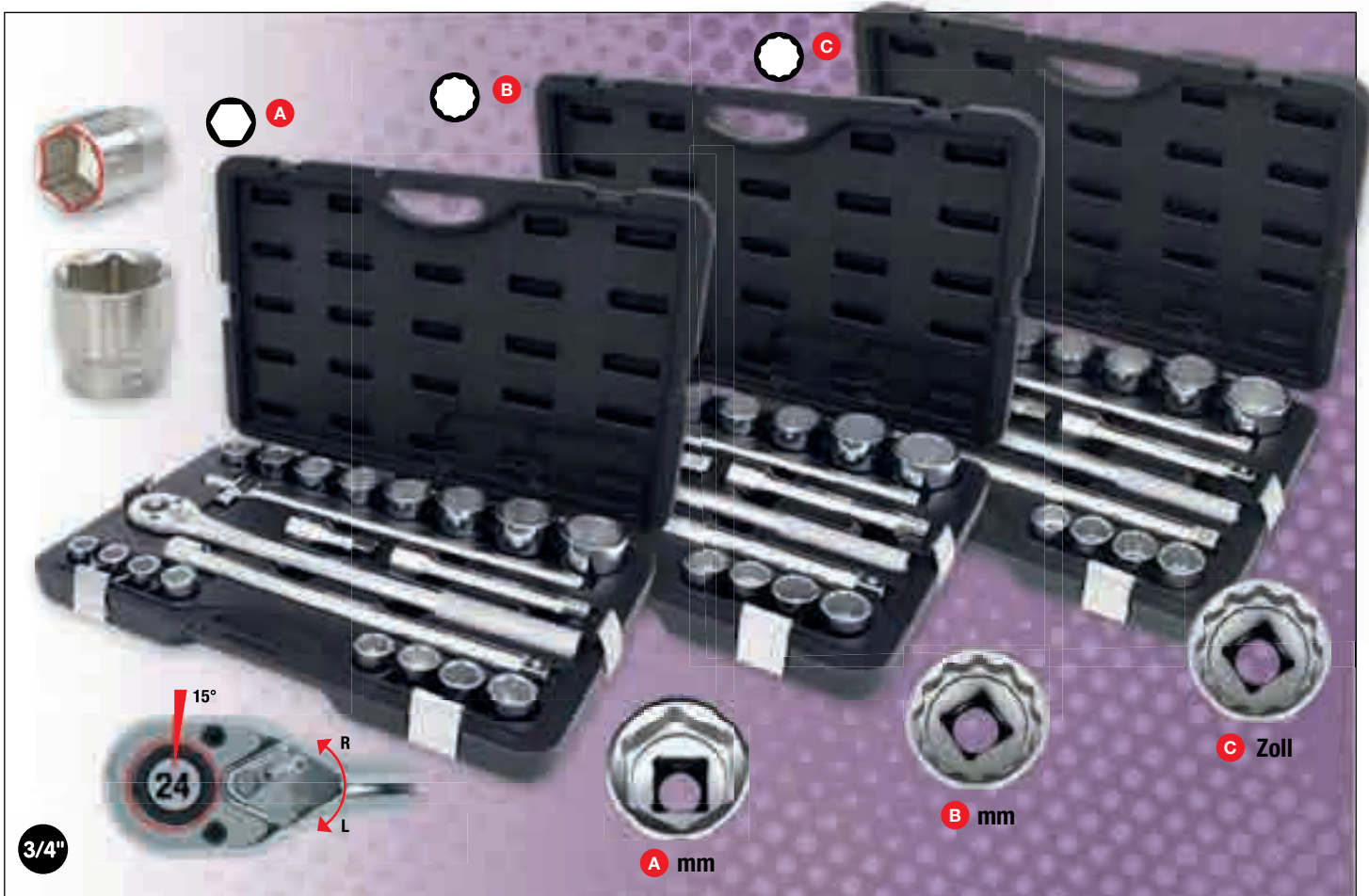

<b>A</b>	911.0721			21		19 · 21 · 22 · 23 · 24 · 26 · 27 · 29 · 30 32 · 35 · 36 · 38 · 41 · 46 · 50 mm	219, <sup>90</sup> €
<b>B</b>	911.0722			21		19 · 21 · 22 · 23 · 24 · 26 · 27 · 29 · 30 32 · 35 · 36 · 38 · 41 · 46 · 50 mm	248, <sup>50</sup> €
<b>C</b>	911.0751			21		3/4" · 13/16" · 7/8" · 15/16" · 1" 1.1/16" · 1.1/8" · 1.3/16" · 1.1/4" 1.5/16 · 1.3/8" · 1.7/16" · 1.1/2" 1.5/8" · 1.3/4" · 2"	248, <sup>50</sup> €

**ab**  
**219,<sup>90</sup>**

			82
<b>Weitere Informationen</b>			
			4 - 4,5 - 5 - 5,5 - 6 - 7 - 8 - 9 - 10 - 11 12 - 13 - 14 mm
			14 - 15 - 16 - 17 - 18 - 19 - 20 - 21 - 22 24 - 27 - 30 - 32 mm
			16 - 21 mm
			150 mm
			50 - 100 - 125 - 250 mm
			150 mm
			8 - 10 - 11 - 12 - 13 - 14 - 17 - 19 - 22 mm

**129,<sup>90</sup>**

**1/4" + 1/2"**

**911.0682**













**vernickelt**

**matt satiniert**



**i**  **47**  
 Weitere Informationen











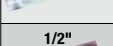

1/2"		10 - 11 - 12 - 13 - 14 - 15 - 16 - 17 18 - 19 - 20 - 21 - 22 - 24 mm
3 x		16 - 18 - 21 mm
14 x		6 - 7 - 8 - 9 - 10 - 11 - 12 - 13 - 14 15 - 16 - 17 - 18 - 19 mm
1 x		250 mm
2 x		125 - 250 mm
1 x		1/2"
5 x		3 - 5,5 - 8 mm + PH1 - PH2
1 x		T8 - T10 - T15 - T20 - T25 - T27 T30 - T40
1 x		2,5 - 3 - 4 - 5 - 6 - 7 - 8 - 10 mm
1 x		3 - 48 V
1 x		240 mm
1 x		180 mm
1 x		300 g







**149,90**

**1/2"**  
 940.0047 

1/4"		4 - 4,5 - 5 - 5,5 - 6 - 7 - 8 - 9 - 10 11 - 12 - 13 mm
1/2"		10 - 11 - 12 - 13 - 14 - 15 - 16 - 17 19 - 20 - 21 - 22 - 24 - 27 - 30 - 32 mm
12 x		8 - 9 - 10 - 11 - 12 - 13 - 14 - 15 - 16 17 - 18 - 19 mm
2 x		1/4": 100 mm / 1/2": 125 mm
1 x		1/4" / 1/2"
7 x		3 - 4 - 5,5 - 6,5 mm + PH0 - PH1 - PH2
1 x		T8 - T10 - T15 - T20 - T25 - T27 - T30 T40 - T45 - T50
1 x		1,5 - 2 - 2,5 - 3 - 4 - 5 - 6 - 8 - 10 mm
1 x		300 g
1 x		160 mm
1 x		200 mm



**1/4" + 1/2"**  
 A matt satiniert B hochglanz verchromt

<b>A</b>	917.0797 	<b>97</b> 	174,90 €
<b>B</b>	918.0797 	<b>97</b> 	189,90 €



**ab**  
**174,90**

**i** **88**  
Weitere Informationen

1/4"		4 - 4,5 - 5 - 5,5 - 6 - 7 - 8 - 9 - 10 - 11 12 - 13 mm
1/2"		14 - 15 - 16 - 17 - 18 - 19 - 20 - 21 - 22 23 - 24 - 25 - 26 - 27 - 28 30 - 32 mm
12 x		6 - 7 - 8 - 9 - 10 - 11 - 12 - 13 - 14 17 - 19 - 22 mm
3 x		1/4": 50 - 100 mm / 1/2": 125 mm
1 x		1/4"
4 x		6,5 - 8 mm PH1 - PH2
1 x		1/4"
1 x		1/4"
1 x		150 - 250 V
1 x		250 mm
1 x		180 mm
1 x		300 g

# 189,90

1/4" + 1/2"

matt  
satiniert

**i** **127**  
Weitere Informationen

## DER ALLESKÖNNER

**1**

4 x

**2**

8 x 8 - 9 - 10 - 11 - 13  
14 - 17 - 19 mm

**3**

**4**

# 369,90

1/4" + 1/2"





400 mm

490 mm



6 x 



1/4"		4 - 4,5 - 5 - 5,5 - 6 - 7 8 - 9 - 10 - 11 - 12 13 mm
		
1/2"		10 - 13 - 14 - 15 - 16 17 - 18 - 19 - 21 - 22 24 - 27 - 30 - 32 mm
10 x		8 - 10 - 11 - 12 - 13 14 - 15 - 17 - 19 - 22 mm



**389,90**



911.0649 **1/4" + 1/2"**

**VOLLAUSSTATTUNG?  
 DANN HIER ZUGREIFEN!**







6 x   
 3 x 



9 x		1,5 - 2 - 2,5 - 3 - 4 - 5 - 6 8 - 10 mm
9 x		TS10 - TS15 - TS20 - TS25 TS27 - TS30 - TS40 - TS45 TS50



1/4"		4 - 4,5 - 5 - 5,5 - 6 - 7 8 - 9 - 10 - 11 - 12 13 mm
		
1/2"		10 - 11 - 12 - 13 - 14 15 - 16 - 17 - 18 - 19 21 - 22 - 24 - 27 - 30 32 mm
11 x		8 - 9 - 10 - 11 - 12 13 - 14 - 16 - 17 - 19 22 mm



**449,90**

911.0630 **1/4" + 1/2"**

# FÜR ELEKTRIKER



4 x

1/4" 4 - 4,5 - 5 - 5,5 - 6 - 7 - 8  
 9 - 10 - 11 - 12 - 13 mm

1/2" 10 - 11 - 12 - 13 - 14 - 15  
 16 - 17 - 18 - 19 - 21 - 22 mm

10 x 8 - 10 - 11 - 12 - 13 - 14  
 15 - 17 - 19 - 22 mm

**389,<sup>90</sup>**

911.0628

# DER ALLROUNDER

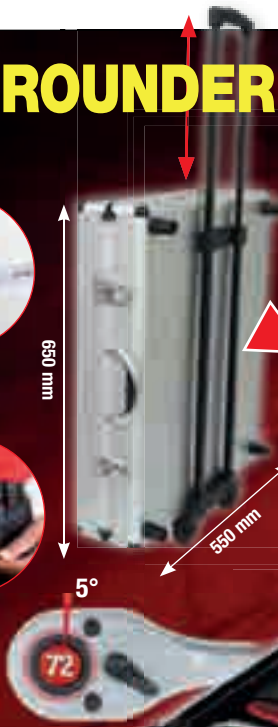

1/4" 4 - 5 - 6 - 7 - 8 - 9 - 11  
 12 - 13 mm

1/2" 10 - 11 - 12 - 13 - 14 - 15 - 16  
 17 - 18 - 19 - 21 - 22 - 24 mm

10 x 8 - 9 - 10 - 11 - 12 - 13  
 14 - 16 - 17 - 18 - 19 mm

**519,<sup>90</sup>**

911.0735

# DIE SCHATZTRUHEN!

**i**  **99**  
Weitere Informationen

**i**  **99**  
Weitere Informationen

<b>1/4"</b>	4 - 5 - 6 - 7 - 8 - 9 - 10 - 11 - 12 13 - 14 mm
<b>1/2"</b>	13 - 15 - 17 - 18 - 19 - 20 - 21 - 22 24 - 27 - 30 - 32 mm



**SIE HABEN  
DIE WAHL!**

**RATSCHENRINGMAULSCHLÜSSEL**  
8 - 9 - 10 - 11 - 12 - 13 - 14 - 15 - 16 - 17 - 18 - 19 mm

**RINGMAULSCHLÜSSEL**  
8 - 9 - 10 - 11 - 12 - 13 - 14 - 15 - 16 - 17 - 18 - 19 mm

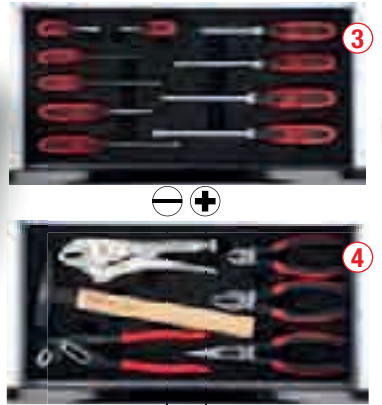



**599,<sup>90</sup>**

**1/4" 1/2"**

**519,<sup>90</sup>**

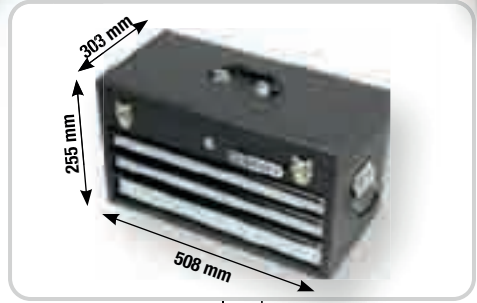
**1/4" 1/2"**



918.0100 

918.0200 

**i**  **40**  
Weitere Informationen

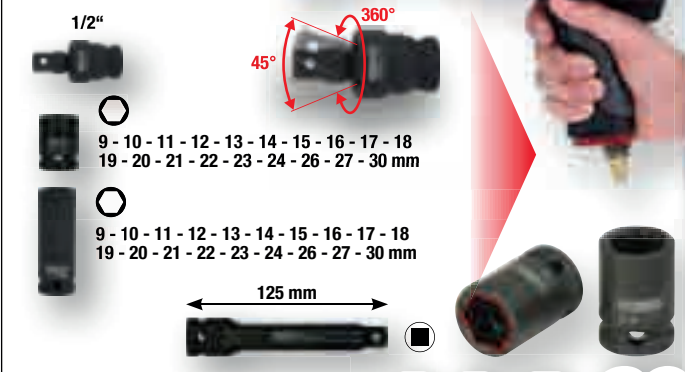

**114,<sup>90</sup>**

**1/2"**  
515.0065





1  
Weitere Informationen







ab  
99,90

Skala mit Lupe

Mikrometerskala

		Nm	Teilung Nm	Lbf-ft		
516.1402		1/4"	1-5	0,10	0,8 - 3,6	99,90 €
516.1412		1/4"	5-25	0,10	0,8 - 18	99,90 €
516.1422		3/8"	10-50	0,25	4 - 37	99,90 €
516.1432		1/2"	20-100	0,50	8 - 75	110,90 €
516.1442		1/2"	40-200	1,00	15 - 150	110,90 €
516.1472		1/2"	60-320	1,00	45 - 236	124,90 €
516.1482		1/2"	80-420	1,00	60 - 310	135,90 €
516.1493		3/4"	150-750	10,00	150 - 550	588,90 €
516.1495		1"	200-1000	20,00	220 - 730	673,90 €





8  
Weitere Informationen

3 IN 1



LANG

9,90

A	151.2100			8	● 2 - 2,5 - 3 - 4 - 5 - 6 8 - 10 mm	9,90 €
B	151.2300			8	★ T10 - T15 - T20 - T25 T30 - T40 - T45 - T50	9,90 €





22  
Weitere Informationen



LANG

12,90

	151.4000			22	● 1,27 - 1,5 - 2 - 2,5 - 3 - 3,5 - 4 - 4,5 - 5 - 6 - 7 - 8 - 10 mm  ★ T10 - T15 - T20 - T25 - T27 - T30 T40 - T45 - T50	12,90 €
--	----------	--	--	----	-------------------------------------------------------------------------------------------------------------------------------	---------

DIE WICHTIGSTEN 22  
IN EINEM SATZ

**32**  
Weitere Informationen

vernickelt

1 x		1/4"
1 x		1/4"
3 x		PH1 - PH2 - PH3
6 x		2 x PZ1 - 2 x PZ2 - 2 x PZ3
3 x		5,5 - 6,5 - 8 mm
3 x		4 - 5 - 6 mm
15 x		2 x TB10 - 3 x TB15 - 2 x TB20 3 x TB25 - 3 x TB30 - 2 x TB40

911.2060

25 mm  
50 mm

**32**  
Weitere Informationen

**TORION power**

+30%

1 x		1/4"
1 x		1/4"
4 x		3 - 4 - 5 - 6 mm
4 x		PH1 - 2 x PH2 - PH3
4 x		PZ1 - 2 x PZ2 - PZ3
4 x		3 - 4 - 5 - 6 mm
7 x		T10 - T15 - T20 - T25 - T27 - T30 - T40
7 x		TB10 - TB15 - TB20 - TB25 - TB27 - TB30 - TB40

911.3030

8,90

9,90

**108**  
Weitere Informationen

**TORION power**

29,90

NEU

+30%

6x: 4 - 5 - 6 mm
6x: 4 - 5 - 6 mm
6x: PH1 - PH2 - PH3
6x: PZ1 - PZ2 - PZ3
6x: T10 - T15 - T20 - T25 - T30 - T40

108 BITS, DIE DEN UNTERSCHIED MACHEN

918.3108 1/4"

**32**  
Weitere Informationen

68 mm  
100 mm

**32**  
Weitere Informationen

4 x		3 - 4 - 5 - 6 mm
4 x		PH1 - 2 x PH2 - PH3
4 x		PZ1 - 2 x PZ2 - PZ3
4 x		3 - 4 - 5 - 6 mm
7 x		T10 - T15 - T20 - T25 - T27 - T30 - T40
7 x		TB10 - TB15 - TB20 - TB25 - TB27 - TB30 - TB40

44,90

918.3010 1/4"

**31**  
Weitere Informationen

**TORION power**

**31**  
Weitere Informationen

2 x		4 - 5 mm
3 x		PH1 - PH2 - PH3
3 x		PZ1 - PZ2 - PZ3
9 x		1,5 - 2 - 2,5 - 3 - 4 - 5 - 6 - 7 - 8 mm
11 x		T6 - T7 - T8 - T9 - T10 - T15 - T20 - T25 - T27 - T30 - T40

57,90

918.3015 1/4"

**i** **24**  
 Weitere Informationen

**KLEIN & FEIN**

25 mm  
 vernickelt

**19,90**

1 x		1/4": 92 mm
1 x		1/4": 50 mm
1 x		1/4"
6 x		6 - 7 - 8 - 10 - 11 - 13 mm
2 x		PH1 - PH2
2 x		PZ1 - PZ2
2 x		4,5 - 5,5 mm
4 x		3 - 4 - 5 - 6 mm
5 x		TB10 - TB15 - TB20 - TB25 - TB30

911.2010 **1/4"**

**i** **208**  
 Weitere Informationen

**39,90**

**DER ALLES-SCHRAUBER!**

1/4"		1/4": 205 mm
138 x		25 mm
29 x		50 mm
18 x		75 mm
20 x		4 - 5 - 6 - 7 - 8 - 9 - 10 - 11 - 12 - 13 mm 5/32" - 3/16" - 7/32" - 1/4" - 9/32" 5/16" - 11/32" - 3/8" - 7/16" - 1/2"
1 x		1/4": 50 mm
1 x		1/4"

25 mm 50 mm 75 mm

911.2008 **1/4"**

**i** **7**  
 Weitere Informationen

**DAS KLEINE  
 TECHNIKWUNDER!**

**9,90**

**6  
 IN ONE**

**NEU**

110 mm

1/4"

	4 - 5 mm
	PH1 - PH2
	PZ1 - PZ2

159.2025 **6 in 1 Mini-Ratschen-Schraubendreher**

**i** **13**  
 Weitere Informationen

**14,90**

**12  
 IN ONE**

240 mm

1/4"

	4 - 5 - 6 mm
	PH1 - PH2 - PH3
	3 - 4 - 5 mm
	T15 - T20 - T25

159.2035 **12 in 1 Ratschen-Bit-Schraubendreher**



**i** **1**  
Weitere Informationen

**2 IN 1**

**1/4"**

**85 mm**

**8,90**

**ODER**

**i** **1**  
Weitere Informationen

**1/4"**

**10,90**

**MIT GELENK**

**90 mm**

**20°**

**i** **21**  
Weitere Informationen

**4 mm**

**30 mm** **165 mm**

**Ø 16 mm**

**39,90**

**1 - 1,3 - 1,5 - 2 - 2,5 - 3 mm** **PH00 - PH0 - PH1 - PH2** **1,5 - 2 - 2,5 - 3 - 3,5 mm** **T3 - T4 - T5 - T6 - T7**

**i** **27**  
Weitere Informationen

**LED**

**1/4"**

**KSTOOLS**

**EINMAL BERÜHRT, FÜR IMMER VERFÜHRT.**

**max 6 Nm**

**max 4 Nm**

**max 2 Nm**

**34,90**

**515.3600**

60		5,5 - 6,0 - 6,5 - 7,0 mm
61		5,0 - 6,0 - 7,0 - 8,0 mm
62		PH0 - PH1 - PH2 - PH3
63		PH0 - PH1 - PH2 - PH3
64		T3 - T4 - T5 - T6
65		40 - 41 - 42 - 43
66		PH0
67		PH0
68		PH0



51



Weitere Informationen

# DER ALLROUNDER



## 1 Bohren



## 2 Reinigen



## 3 Schleifen



23x



## 4 Gravieren



## 5 Trennen



## 6 Polieren



**eMONSTER**  
Akku-Multifunktions-  
werkzeug-Satz mit  
50 Zubehörteilen



# eMONSTER



50



Weitere Informationen

## ZUM NACHKAUFEN



Zubehör-Satz, 50-tlg

# 49,<sup>90</sup>

515.3990

# 9,<sup>90</sup>

515.3992

# DER TRANSFORMER UNTER DEN SCHRAUBERN



eMONSTER

Hohe 210 RPM  
Drehzahl, dadurch  
5 x schneller als  
manueller  
Anziehungs-  
vorgang

praktische Batterie-  
Ladezustandsanzeige  
mit 3 LEDs

verstärktes  
Getriebe



2 in 1 Gerät mit ausgewogenem Verhältnis zwischen Leistung und Größe, ideal zum Arbeiten über Kopf und an engen Stellen.

magnetische  
Bitaufnahme

verbesserter  
Griffkomfort

1.3 Ah Akku  
mit einer Laufzeit  
für  
**1000+**  
Schrauben

Drehmomentvorwahl in  
10 Stufen einstellbar

integrierte Lampe

Der Li-ION-Hochleistungsakku  
ist dank USB-C Anschluss auch  
schnell wieder aufgeladen und  
einsatzbereit.

Ein Überdrehen der Schrauben wird  
durch automatisches Verriegeln  
des Motors bei Überschreiten des  
Drehmoments verhindert.



**i** **27**  
Weitere Informationen

inkl.  
25 Bits

**39,90**

515.6500

# ERGOTORQUE



verchromt mit  
brüniertes Spitze



mit Profilkennzeichnung  
am Griff

**i** **5** **159.0005**

Weitere Informationen

**9,90**

PH1 PH2 6,5 mm 5,5 mm 4 mm

**i** **6** **159.0030**

Weitere Informationen

**19,90**

T10 T15 T20 T25 T30 T40

**i** **6** **159.0040**

Weitere Informationen

**19,90**

TB10 TB15 TB20 TB25 TB30 TB40

**i** **39**

Weitere Informationen

**50,90**

6 x		3 - 4 - 5,5 - 6,5 8 - 10 mm	7 x		2 - 2,5 - 3 - 4 - 5 6 - 8 mm
5 x		PH0 - PH1 - PH2 PH3 - PH4	7 x		TB10 - TB15 - TB20 TB25 - TB27 - TB30 TB40
4 x		PZ0 - PZ1 - PZ2 PZ3	7 x		T10 - T15 - T20 T25 - T27 - T30 T40
1 x		6 mm	1 x		1/4"
1 x		PH2	1 x		205 mm

**159.0100** **1/4"**

**i** **13**

Weitere Informationen

**DER VERTRÄGT SCHLÄGE!**

**67,90**

durchgehende Klinge

5 x		3,5 - 5,5 - 7 - 8 - 10 mm
5 x		PH0 - PH1 - PH2 - PH3 - PH4
1 x		6 mm
1 x		PH2
1 x		1/4"

**151.1150** **1/4"**

**i** **15**  
Weitere Informationen

260 mm

**A**

**67,90**

150.9805

		<b>A</b>	<b>B</b>
		150.9805	150.9630
	Niete (Alu)	<input checked="" type="checkbox"/>	<input checked="" type="checkbox"/>
	Niete (Stahl)	<input checked="" type="checkbox"/>	<input checked="" type="checkbox"/>
	Mutter	<input checked="" type="checkbox"/>	<input checked="" type="checkbox"/>
	im Koffer	<input checked="" type="checkbox"/>	<input checked="" type="checkbox"/>
	Länge mm	260	510
	Blechknabber	<input checked="" type="checkbox"/>	<input checked="" type="checkbox"/>
	Ein- oder Zweihand-Bedienung		
	M10	<input checked="" type="checkbox"/>	<input checked="" type="checkbox"/>
	M8	<input checked="" type="checkbox"/>	<input checked="" type="checkbox"/>
	M6	<input checked="" type="checkbox"/>	<input checked="" type="checkbox"/>
	M5	<input checked="" type="checkbox"/>	<input checked="" type="checkbox"/>
	M4	<input checked="" type="checkbox"/>	<input checked="" type="checkbox"/>
	M3	<input checked="" type="checkbox"/>	<input checked="" type="checkbox"/>
	Stahl 4,8 mm	<input checked="" type="checkbox"/>	<input checked="" type="checkbox"/>
	Stahl 4,0 mm	<input checked="" type="checkbox"/>	<input checked="" type="checkbox"/>
	Stahl 3,2 mm	<input checked="" type="checkbox"/>	<input checked="" type="checkbox"/>
	Stahl 2,4 mm	<input checked="" type="checkbox"/>	<input checked="" type="checkbox"/>
	ALU 6,4 mm	<input checked="" type="checkbox"/>	<input checked="" type="checkbox"/>
	ALU 4,8 mm	<input checked="" type="checkbox"/>	<input checked="" type="checkbox"/>
	ALU 4,0 mm	<input checked="" type="checkbox"/>	<input checked="" type="checkbox"/>
	ALU 3,2 mm	<input checked="" type="checkbox"/>	<input checked="" type="checkbox"/>
	ALU 2,4 mm	<input checked="" type="checkbox"/>	<input checked="" type="checkbox"/>

**i** **17**  
Weitere Informationen

510 mm

**B**

**174,90**

150.9630



Weitere Informationen





1



ab 10,90







	↔	↔	
115.2011	175 mm	7"	10,90 €
115.2010	240 mm	10"	12,90 €
115.2012	300 mm	12"	15,90 €
115.2016	415 mm	16"	31,90 €







Weitere Informationen







4







PREMIUM QUALITÄT!



Weitere Informationen





4



**A** 19 - 60 mm



**B** 40 - 100 mm

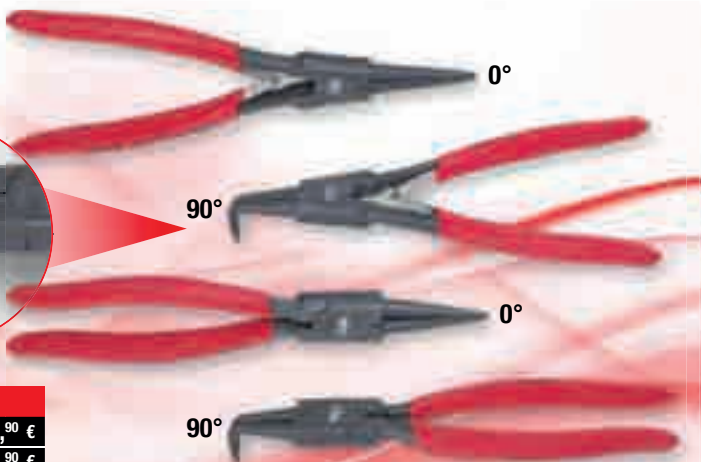

ab 110,90

	↔	↔	
<b>A</b>	119.2055	19 - 60 mm	160 mm
<b>B</b>	119.2060	40 - 100 mm	230 mm



Weitere Informationen





20

SAFETY FIRST



60 - 100 mm



40 - 85 mm

49,90







0°



15°



45°



90°



90°



45°



15°



0°



500.1350

**Sicherungszangen-Satz mit Ratschenfunktion**

# SCHAU MIR IN DIE AUGEN, FEINES!



Weitere Informationen

10

24,90



Weitere Informationen

21

99,90



1 x		120 mm
1 x		120 mm
1 x		120 mm

1 x		160 mm
3 x		PH00 - PH0 - PH1
3 x		2,0 - 2,4 - 3,0 mm

500.7220

2 x		125 - 130 mmf
1 x		100 mm
1 x		100 mm
1 x		125 mm
1 x		150 mm
1 x		145 mm

3 x		PH00 - PH0 - PH1
4 x		1,4 - 2,0 - 2,4 - 3,0 mm
7 x		T6 - T7 - T8 - T9 - T10 - T15 - T20

500.7190



Weitere Informationen

1



mit stabiler, reissnadelähnlicher Einstellspitze



5,90

150 - 675 mm

mit starrem Magnet-Kopf

550.1001 2in1 Teleskop-Magnethalter mit Waschdüsen-Reinigungs- und Einstellwerkzeug



Weitere Informationen

1

9,90

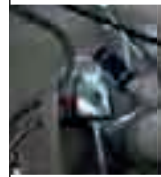

max. 60 h  
1 x GR 2032

260 - 760 mm



550.1136 Flexibler Inspektions-Spiegel mit Beleuchtung



Weitere Informationen

1



mit dünnem Reinigungsstab



7,90

150 - 590 mm

mit flexiblem Magnet-Kopf

550.1023 2in1 Teleskop-Magnethalter mit Waschdüsen-Reinigungs- und Einstellwerkzeug



Weitere Informationen

5

LED + 3 x LR44

NEU

inklusive Schnellverriegelung



Ø 52,0 mm

Ø 31,0 mm

90,0 x 50,0 mm

14,90

5 IN 1



550.1145

172 - 640 mm

**i** **4**  
 Weitere Informationen

**9,90**

45° 135° 0° 90°

550.1045

**i** **9**  
 Weitere Informationen

**19,90**

45° 135° 0° 90° 45° 90° 0°

550.1070

**i** **1**  
 Weitere Informationen

**8,90**

Piezo  
115 mm

960.1110

**i** **1**  
 Weitere Informationen

**19,90**

300 mm

550.1060

**i** **8**  
 Weitere Informationen

**19,90**

95 mm  
 Ø 40 mm  
 49 mm  
 5 mm  
 Ø 1,6 mm  
 Ø 3,5 mm  
 Ø 4,5 mm

960.1265

**ISO BUTAN**

**i** **11**  
 Weitere Informationen

**29,90**

Piezo  
200 mm

20 mm 33 mm Ø 1,6 mm Ø 3,5 mm Ø 4,5 mm Ø 5 mm 30 mm

95 mm 95 mm Ø 40 mm

960.1160 Mikro-Löt-Satz



**i** **283**  
Weitere Informationen

**169,90**

220 mm

Ø 0,5 - 6 mm  
Ø 0,5 - 6 mm  
Ø 0,5 - 10 mm  
Ø 6,50 / 5,41 / 1,72 mm  
Ø 0,5 - 4 mm  
Ø 1,0 - 3,2 mm

115.1400

**i** **1**  
Weitere Informationen

**3,90**

143 mm

118.0013

**i** **1**  
Weitere Informationen

**ab 2,90**

EG II

A 16 mm  
B 19 mm  
C 25 mm  
D 25 mm

	Artikelnummer	Länge	Blattbreite	Preis
A	300.0113	3 m	16 mm	2,90 €
B	300.0114	5 m	19 mm	3,90 €
C	300.0115	5 m	25 mm	4,90 €
D	300.0116	8 m	25 mm	5,90 €

**i** **5**  
Weitere Informationen

Temperaturregulierung:  
1≈50°C / 2≈100°C / 3≈200°C /  
4≈350°C / 5≈550°C / 6≈650°C

260 mm

1 2 3 4 5 6

1 max. 450°C  
2 max. 650°C

Anwendungsgebiete: Entfernen von Farbe, Verlöten von Rohren, Schrumpfen von PVC, Verschweißen und Biegen von Kunststoffen, Trocknungen, Auftauen etc.

**29,90**

960.1190

**i** **1**  
Weitere Informationen

IP 34

15+1 m

3x 1,5 mm<sup>2</sup>

230 V  
50 Hz

1000/3000 W

10 A

180°

**134,90**

150.4217

**i** **12**  
Weitere Informationen

**9,90**

145 mm

5,0 x 1,0 mm  
5,0 x 1,0 mm  
3,0 mm  
3,0 mm  
5,0 mm  
5,0 mm  
3,0 mm  
2,0 mm  
2,0 mm  
5,0 mm  
5,0 mm  
5,0 mm

140.3050

**i** **5**  
Weitere Informationen

**29,90**

200 mm

140.3000

**i** **1**  
Weitere Informationen

143 x 70 x 16 mm 119 AAA Data Hold

**19,90**

69 mm 138 mm

150.1495

**i** **1**  
Weitere Informationen

3 - 48 V

140 mm

**11,90**

550.1503 **Polaritäts- und Spannungsprüfer 3 - 48 V**

**i** **1**  
Weitere Informationen

125 mm

6 - 24 V

**4,90**

550.1504 **Prüflampe 6 - 24 V**

**i** **1**  
Weitere Informationen

**AUTOMATIC**  
DIGITAL MULTIMETER

143 x 70 x 16 mm 119 AAA Data Hold

16 mm

143 mm

70 mm

**49,90**

150.1765

**Nr. Beschreibung**

- Ein-/Aus-Taste
- Funktionsschalter
- Kapazitätsschalter
- Beleuchtungsschalter
- LCD-Display
- NCV-Sensor-Bereich
- Messleitungen

Symbol	Beschreibung
	Gleichspannung
	Wechselspannung
	Anzeige für automatische Abschaltfunktion
	Anzeige für niedrigen Batteriestand
	Dioden-Modus
	Durchgang
	Kapazität
	Leistungsmessverhältnis
<b>HOLD</b>	Data-Hold-Funktion
<b>V, mV</b>	Einheit der Spannung: Volt, Millivolt
<b>mF, µF, nF</b>	Einheit der Kapazität
<b>MΩ, KΩ, Ω</b>	Einheit des Widerstands
<b>NCV</b>	Kontaktlose Spannungsinduktion
<b>Live</b>	Prüfung spannungsführender Leitungen
<b>KHz, Hz</b>	Einheit der Frequenz
<b>°C/°F</b>	Celsius/Fahrenheit

**NCV**

**3 COLOUR ANALOG BAR**

**BUZZER ALARM**

USB-A USB-C

**i** **3**  
Weitere Informationen

210 x 88 x 44 mm    655    9V    Data Hold

**34,<sup>90</sup>**

27,0 mm

max. messbarer Leiterdurchmesser 29,0 mm

150.0925

**i** **1**  
Weitere Informationen

für Gleich- und Wechsellspannung

AC	6 - 50 - 120 - 230 - 400 V
DC	6 - 50 - 120 - 230 - 400 V

**23,<sup>90</sup>**

550.1501

# UNIVERSAL-SCHLTSCHRANKSCHLÜSSEL

**i** **1**  
Weitere Informationen

**MINI**

42 mm

**16,<sup>90</sup>**

- 6 - 7 - 8 mm
- ▲ 9 mm
- 3 - 5 mm
- ⊕ PH 2
- 7 mm

130.1010

**i** **1**  
Weitere Informationen

71 mm

**17,<sup>90</sup>**

- 6 - 7 - 8 mm
- ▲ 9 mm
- 3 - 5 mm
- ⊕ PH 2
- 7 mm

130.1015

**i** **1**  
Weitere Informationen

61 mm

**17,<sup>90</sup>**

- 5 - 7 - 8 mm
- ▲ 9 - 10 mm
- 4 - 10 mm
- ⊕ PH 2
- 7 mm

130.1020

**Kabel-Einziehdraht**

10 Meter    20 Meter

**ab 4,<sup>90</sup>**

<b>A</b>	150.0960		<b>1</b>	∅ 3,0 mm 10 m	4, <sup>90</sup> €
<b>B</b>	150.0970		<b>1</b>	∅ 4,0 mm 20 m	9, <sup>90</sup> €

**i** **1**  
Weitere Informationen

**34,<sup>90</sup>**

∅ 3,0 mm

30 Meter

115.1113    Kabeleinziehilfe

**i**  **1**  
Weitere Informationen

**22,90**



- mit Momentfeststellung
- Messschieben in mm und Zoll-Teilung
- mit Gewindetabelle

300.0510

**i**  **1**  
Weitere Informationen

**24,90**



- mit Feststellschraube und Rollenfeineinstellung
- für Außen-, Innen-, Stufen- und Tiefenmessungen

$\pm 0.03 \text{ mm}$

300.0532

**i**  **1**  
Weitere Informationen

**INFRAROT-THERMOMETER, -38° BIS 520°**



**49,90**

150.3040

**i**  **4**  
Weitere Informationen

**56,90**



Refraktometer - optisches Prüfgerät für Batterieflüssigkeit und Frostschutzmittel

550.1290

**i**  **4**  
Weitere Informationen

**67,90**



Refraktometer - optisches Prüfgerät für Batterieflüssigkeit, Frostschutzmittel und AdBlue®-Zusätze

550.1285

**i** **4**  
Weitere Informationen

**19,90**

11 x 115 mm  
15 x 185 mm  
18 x 320 mm  
18 x 470 mm

**911.8100 Hebeleisen-Satz**

**i** **4**  
Weitere Informationen

**XL**

900 mm  
600 mm

0°  
45°  
75°  
90°

**179,90**

**911.8410 Hebeleisen-Satz**

**i** **22**  
Weitere Informationen

**Hydraulischer Universal-Abzieher-Satz  
2+3-armig**

- geringe Abrutschgefahr durch automatisch schließende Abzieherarme
- 8 Abziehervarianten möglich
- extrem robuste Spindel mit induktiv gehärtetem Gewinde
- geringer Kraftaufwand
- Spezial-Werkzeugstahl

**304,90**

**700.1200**

20 - 35 - 85 mm  
235 mm  
185 mm  
10 t, AG 1 1/2" x 16G  
225 mm  
170 mm  
120 mm  
Ø max. 100 mm

**i** **13**  
Weitere Informationen

**NEU**

**FÜR NOTFÄLLE**

**79,90**

**0% ✓** **85% ✓**

zum Lösen und Herausdrehen von feststehenden Muttern und Schrauben mit beschädigten oder bis zu 85% „rundgedrehten“ Köpfen

**89,90**

Ringe 45° gekröpft

**913.3930** 3/8" 1/2" 8 - 9 - 10 11 - 12 - 13 - 14 - 15 - 16 - 17 - 18 - 19 mm **3/8"**

**517.1555** 6x7 - 8x9 - 10x11 - 12x13 - 14x15 - 16x17 - 18x19 mm

**i**  **6**  
 Weitere Informationen

- für Schrauben von M3 - M18
- ermöglicht das Ausdrehen von abgerissenen Schrauben und Bolzen
- konisch zulaufende Spirale
- in stabiler Kunststoffbox

**16,90**

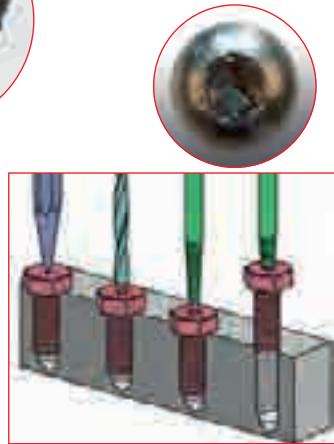





150.1330 Schrauben-Ausdreher-Satz

**i**  **34**  
 Weitere Informationen

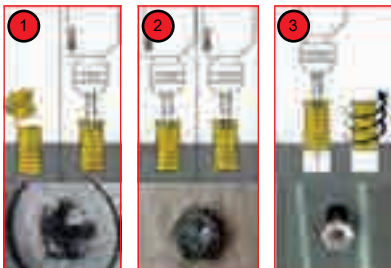
**TORION power**

**44,90**



9 x		TE10 - TE15 - TE20 - TE25 - TE27 - TE30 - TE40 - TE50 - TE55
9 x		1,5 - 2 - 2,5 - 3 - 4 - 5 - 6 - 8 - 10 mm
7 x		1,5 - 2 - 2,5 - 3 - 4 - 5 - 6 mm
7 x		T10 - T15 - T20 - T25 - T27 - T30 - T40

150.7060    1/4" + 10 mm Torx- und Innensechskant-Schrauben-Ausdreher-Satz

**i**  **25**  
 Weitere Informationen

**Gewindeausdreh-Satz**

- umfangreiche Satzzusammenstellung
- zum Entfernen von abgebrochenen Gewindebolzen und Schrauben
- keine Beschädigung des Gewindes
- nur geringfügiges Aufweiten der Gewindebolzen durch speziell profilierte Ausdrehstifte

Führungshülse drill guide	Hülse Innen- Ø mm guide	vorböhren Ø mm pre-drilling	aufbohren re-drilling	Stift pin	Art.Nr. Stift No. Pin	Mutter D nut D	Art.Nr. Mutter nut D	Stift + Mutter pin + nut
150.0501	4,0 / 3,2	3,2	-	3,2	150.0521	SW 10	150.0511	150.0511S
150.0502	4,8 / 3,2	3,2	-	3,2	150.0521	SW 10	150.0511	150.0511S
150.0503	4,8 / 3,2	3,2	4,8	4,8	150.0522	SW 11	150.0512	150.0512S
150.0504	4,8 / 3,2	3,2	4,8	4,8	150.0522	SW 11	150.0512	150.0512S
150.0505	6,0 / 4,8	4,8	6,4	6,4	150.0523	SW 13	150.0513	150.0513S
150.0506	7,0 / 4,8	4,8	6,4	6,4	150.0523	SW 13	150.0513	150.0513S
150.0507	7,0 / 4,8	4,8	8,0	8,0	150.0524	SW 14	150.0514	150.0514S
150.0508	7,0 / 4,8	4,8	8,7	8,7	150.0525	SW 17	150.0515	150.0515S
150.0509	9,0 / 6,5	6,4	8,7	8,7	150.0525	SW 17	150.0515	150.0515S
150.0510	9,5 / 6,5	6,4	8,7	8,7	150.0525	SW 17	150.0515	150.0515S

**39,90**

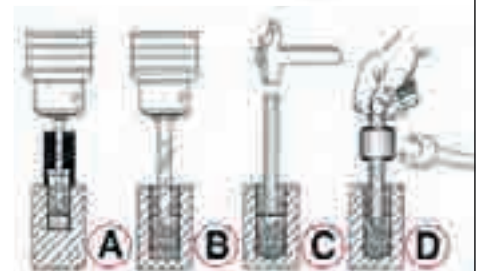

150.1305 M5 - M6 - M8 - M10 - M12 - M14 - M16



Weitere Informationen

### Stehbolzen-Ausdreher-Satz

- Außensechskantantrieb 21,0 mm
- mit Rechts- und Linksspannfunktion
- sicherer Halt durch je 3 Rollwalzen
- Ein- und Ausdrehen ohne umständliches Verkontern zweier Muttern auf dem Bolzen
- auch für überlange Stehbolzen geeignet - da durchgehend gebohrt

# 49,90

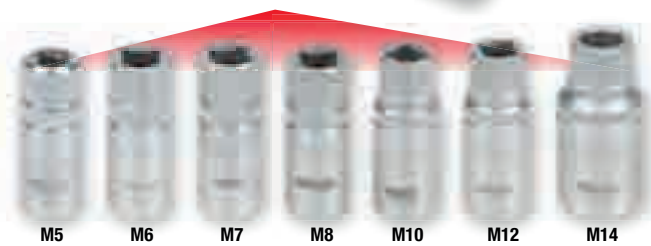

152.1101 M5 - M6 - M7 - M8 - M10 - M12 - M14



Weitere Informationen

### HSS Co Gewindeschneidwerkzeug-Satz in Industriekassette

- universaler Satz
- gerade genutete Handgewindebohrer
- mit verstellbarem Windeisen und Schneideisenhalter
- inklusive Gewindelehre und Schraubendreher
- kobaltierter Hochleistungs-Stahl



## DEM FEHLT ES AN NICHTS

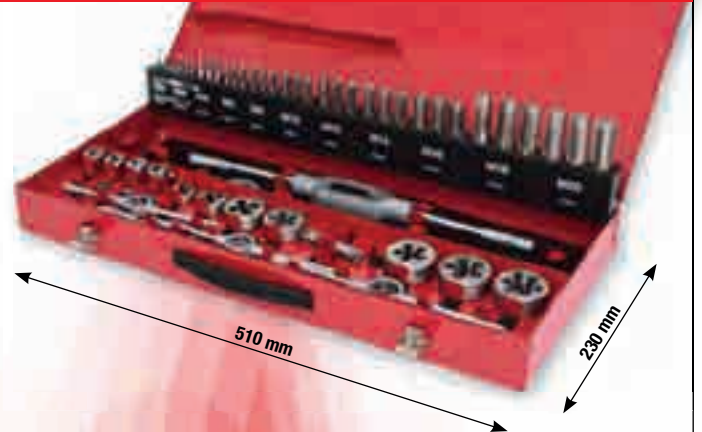

33 x		M3 - M4 - M5 - M6 - M8 - M10 - M12 M14 - M15 - M18 - M20
11 x		M3 - M4 - M5 - M6 - M8 - M10 - M12 M14 - M15 - M18 - M20
6 x		M3-M4 - M4,5-M6 - M7-M9 - M10-M11 - M12-M14 - M16-M20
2 x		M1-M10 - M5-M20

# 499,90

331.0754



Weitere Informationen

### TRÄGT JEDER GERNE!



# 24,90

EN388



4131X

Mikro-Feinstrick

	Größe	Inhalt
310.0490	7	12 Paar
310.0491	8	12 Paar
310.0470	9	12 Paar
310.0475	10	12 Paar
310.0480	11	12 Paar



Weitere Informationen

# 3,90



310.0120

**FLAME DESIGN**

Weitere Informationen

**49,90**

310.0155

**STEEL DESIGN**

Weitere Informationen

**49,90**

310.0195

EN 379 1/1/1/2	EN 175
<b>Technische Daten:</b>	
Farbauswahl:	stufenlos regelbar von DIN 9-13
	Standard Lichteinstellung: DIN 4
Umschaltreaktionszeit:	1/25.000 s
	0,2 - 0,8 s Verzögerung (einstellbar)
UV / IR Schutz:	nach EN169 / bis DIN 16
Betriebstemperatur:	-5°C bis + 55°C
Lagertemperatur:	-20°C bis + 70°C
Stromversorgung:	über Solarzellen
Höhe:	220 mm
Breite:	200 mm
Länge:	295 mm
Gewicht:	480 g
Maße Kassette:	110 x 90 x 9 mm
Sichtfenster:	92 x 42 mm

**Universal-Druck-Zerstäuber**

Weitere Informationen

- aus hochwertigem Polyethylen
- für verschiedene Chemikalien wie z.B. Wasch-, Lösungs- und Reinigungsmittel etc.
- für Bremsenreiniger ungeeignet
- Sprühkopf aus Messing verstellbar und verschleißbar
- Dichtungen aus Viton®
- geeignet für Überkopf-Arbeiten

**für Bremsenreiniger ungeeignet**

**ab 14,90**

150.8251	1L	14,90 €
150.8252	2L	19,90 €

**0,25 L** max. 8 bar (116 psi) 60°C / 140°C

Weitere Informationen

**NEU**

**Speziell für Bremsenreiniger**

**Aluminium**

**0,25 L**

**49,90**

150.8272



**16**  
 Weitere Informationen

**Evolution**  
 SERIES

**Schaber-Satz**

- ideal zum Entfernen von Plaketten, Dichtungs- und Klebstoffresten
- einfacher Klingenwechsel durch Lösen der Rändelschraube am Spannfutter
- praktisches Aufbewahrungssystem durch wechselbare Klingenformen
- bestens geeignet für unterschiedlichste Anwendungsbereiche durch verschiedene Klingen
- Schaber mit 2-Komponentengriff

Ersatzklingen: 907.2202, 907.2203, 907.2204, 907.2205, 907.2206

**NEU**

5x 12 mm  
 5x 16 mm  
 5x 20 mm

145 mm

**12,90**

907.2255

**27**  
 Weitere Informationen

**Messer-Schaber-Satz**

5x 19 mm

145 mm

5x 12 mm  
 5x 16 mm  
 5x 16 mm  
 5x 20 mm

145 mm

**19,90**

907.2200

**Plaketenschaber**

A 110 mm  
 B 145 mm

**ab 3,90**

A	907.2240		1	110 x 39 mm	3,90 €
B	907.2242		1	145 x 40 mm	4,90 €

**Klappmesser mit Arretierung**

A 190 mm  
 B 220 mm

**ab 10,90**

A	907.2105		1	190 x 25 mm	10,90 €
B	907.2190		1	220 x 28 mm	11,90 €

**2**  
 Weitere Informationen

**14,90**

155 mm  
 97 mm

**+**

907.2172 **Klappmesser-Satz**

**3**  
 Weitere Informationen

**39,90**

250 mm

**+**

118.0050 **Hebel-Blechdurchgangsscheren-Satz**

**i** **5**  
 Weitere Informationen

Wi-Fi-Videoskop-Satz mit Ø 5,5 mm 0° HD Frontkamera-Sonde

**HD**

Ø 5,5 mm

IP68

Ø 5,5 mm

3500 mm

**WiFi**

**39,90**

550.7560

**EXTEND YOUR EYE**

**ab 239,90**

Edelstahlhülle  
Schraubanschluss  
für Zubehör

Kronendesign  
(Schutz +  
optimale  
Reinigung)

Kamera  
Linse  
LED  
Edelstahlhülle  
mit Außengewinde  
Saphirglas

1500 mAh  
Li-polymer

Ø 6,0 mm

Ø 4,5 mm

1000 mm

Anschluss Sonde

3,5"

USB 2.0

microSD

**HD**

6 dimmbare  
Mini-LED-  
Lampen

Ø

0° 90°

Ø

0° + 90°

239,90 €

**A** 550.7500 **5**

Ø 6,0 mm

0° + 90°

239,90 €

**B** 550.7530 **7**

Ø 4,5 mm

0° + 90°

299,90 €

1000 mm

50 mm

**IP 67**

AVI  
1280 x 720

JPG

150 mm

-10°/+60°C

**A** **+** Magnet

**B** **+** Magnet

Haken



**i**  **3**  
Weitere Informationen



6 dimmbare  
Mini-LED-  
Lampen

Ø  
3,9 mm

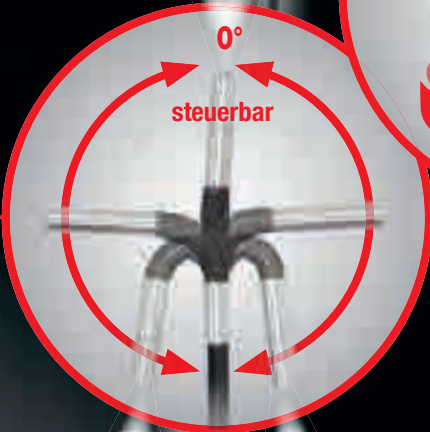

180° 180°

Anschluss Sonde



**NEU**

**449,90**

**+ 32 GB**

550.7550 **HD-Videoskop-Satz mit Ø 3,9 mm 180° und 0° HD Frontkamera-Sonde, flexible PVC Hülle**

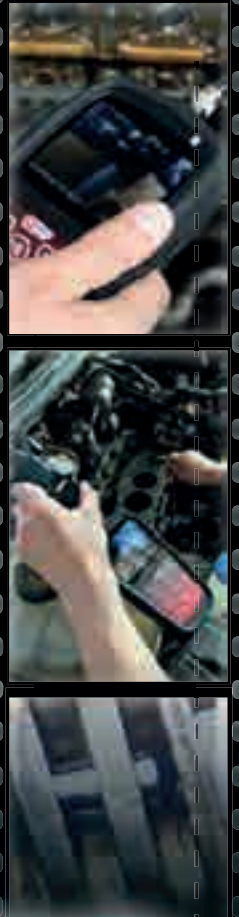



Ø 12 - 35 MM

104.5060 **Inox** **Steel**

Ratschen-Rohrabschneider

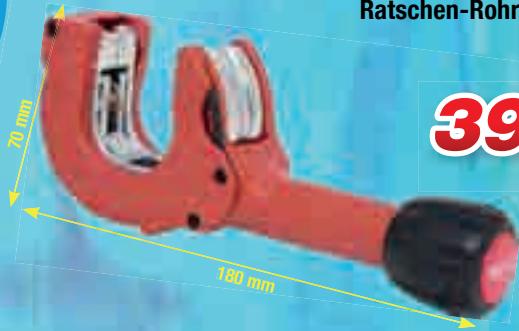

**39,90**



Ø 28 - 67 MM

104.5050 **Inox** **Steel**

Ratschen-Rohrabschneider



**129,90**

116.1050

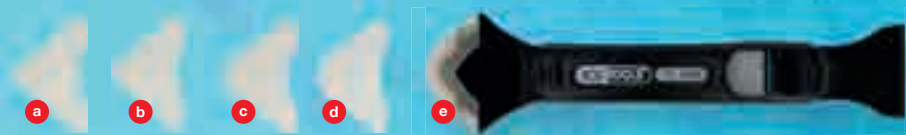

**FUGENFIX**®

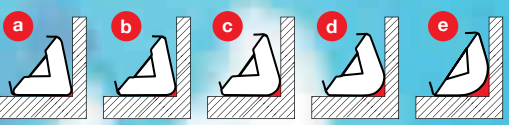

**7,90**

FUGENFIX Silikonschaber- und Abziehersatz

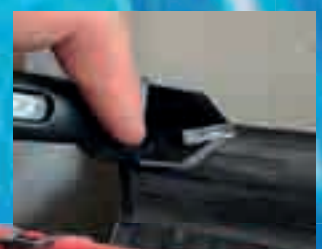

903.3300

Gewinde-Schneidkluppen-Satz



3/8"  
1/2"  
3/4"  
1"  
1.1/4"

**79,90**



116.2000



**57,90**

Ventilfix

130.3000 1/2"

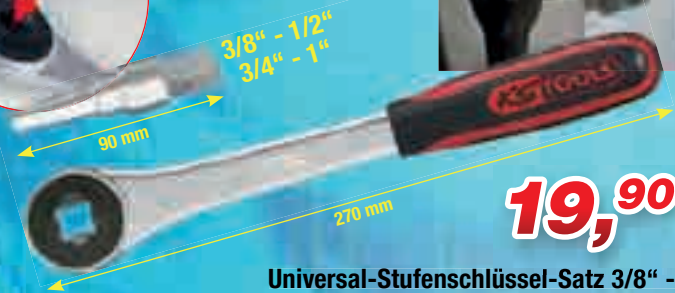

**19,90**

Universal-Stufenschlüssel-Satz 3/8" - 1"

903.5902

- Flammentemperatur ca. 1700°C
- Arbeitstemperatur ca. 650°C
- Weichlöten bis max. Ø 22 mm
- Lieferung erfolgt ohne Gaskartusche
- Verwendung nur mit Standard-Hochleistungsbrenner
- Grundkörper aus Kunststoff



Piezo



**24,90**

Universal-Kartuschenlötgerät mit Piezo-Zündung

907.2113

Japan-Zugsäge, doppelverzahnt



17x pro 2,5cm

8x pro 2,5cm

325 mm

**17,90**

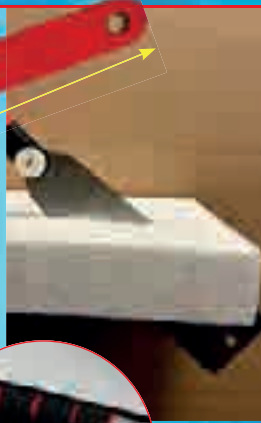

850.0300

SMARTBAG Universal-Werkzeugtasche

**73,90**

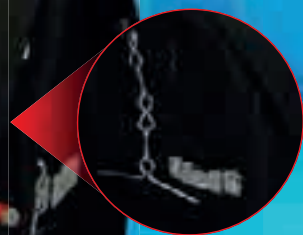

NEU



### Kompakte und robuste Bauweise:

Durch hochwertige Kunststoffe und feste Verschraubungen, bietet der Akku besonders guten Schutz vor mechanischen Einflüssen.



### 18V eMONSTER Akku-System

Das kraftvolle 18V eMONSTER Akku-System vereint eine Reihe von professionellen akkubetriebenen Elektrowerkzeugen. Alle Geräte können mit einem Akku-System betrieben werden. Das Sortiment ist breit aufgestellt und wird stetig erweitert. Jedes neue Gerät kann ebenso mit diesem Akku-System genutzt werden. So können Sie über viele Jahre dieses Akku-System nutzen und mit eMONSTER 18V Geräten erweitern - Sie bleiben in einer Akku-Familie.



### Wärmeableitung:

Durch die Rippenstruktur wird die Wärme wie bei einem Kühler an die Umgebungsluft angeleitet.



### Optimierte Zellanordnung:

Durch die Röhrenstruktur werden die einzelnen Zellen in den wärmeleitenden Kunststoff geschoben. So entsteht ein fester Kontakt zwischen der Zelle und dem wärmeleitenden Kunststoff. Es ist keine isolierende Luftschicht mehr vorhanden, welche die Wärmeableitung verringert.



### Aktive Luftkühlung:

(nur bei 8.0Ah Schnellladegerät) Der integrierte Lüfter des 8.0Ah Schnellladegeräts liefert während dem Ladevorgang durchgehend kühle Frischluft, um entstehende Wärme im Akku und Ladegerät bestmöglich zu reduzieren. Durch diesen schonenden Ladevorgang wird die Lebensdauer des Akkus deutlich erhöht.



### Zusätzlicher Schutz für eine lange Lebensdauer des Akkus:

#### Überspannungsschutz:

- Schutz vor unzulässig hohen Spannungsquellen

#### Niederspannungsschutz:

- Schutz vor Tiefenentladung im Betrieb

#### Temperaturmanagement:

- Zusammenspiel von Gerät und Akku, um eine Überlastung am Akku zu verhindern





### eMONSTER Brushless-Akku-Bohr-Schrauber-Satz

## MINI



# 159,90

Drehmoment max: 40 Nm  
Antrieb: 10 mm Schnellspann-Bohrfutter

515.6400



### eMONSTER Brushless-Akku-Schlag-Bohr-Schrauber-Satz



# 189,90

Drehmoment max: 60 Nm  
Antrieb: 13 mm Röhm-Metall-Schnellspann-Bohrfutter

515.6300

**INKLUSIVE**

Akkuspannung: 18,0 V  
max. Ladestrom: 3 A

Akkuspannung: 18,0 V  
Akkutechnologie: Lithium-Ionen  
Akkukapazität: 2,0 Ah

Lieferung inkl. zwei 2,0 Ah Akkus und 3 A Schnellladegerät

**INKLUSIVE**



### eMONSTER 1/2" Brushless-Akku-Schlag-Schrauber-Satz



# 269,90

max. Löse-Drehmoment: 690 Nm  
Antrieb: 1/2"

515.6100



### eMONSTER Brushless-Akku-Winkelschleifer-Satz



# 299,90

Drehzahl: 9000 U/min  
Vibrationsbeschleunigung: < 4,831 m/s<sup>2</sup>  
3,371 m/s<sup>2</sup>

515.6200

**INKLUSIVE**

Akkuspannung: 18,0 V  
max. Ladestrom: 8 A

Akkuspannung: 18,0 V  
Akkutechnologie: Lithium-Ionen  
Akkukapazität: 4,0 Ah

Lieferung inkl. zwei 4,0 Ah Akkus und 8 A Schnellladegerät



# NEU

### 1/4" TORSIONpower Bit-Satz im eMONSTER-Akku-Design, 32-tlg

# 9,90

515.6932

1 x		1/4"
1 x		1/4"
4 x		3 - 4 - 5 - 6 mm
4 x		PH1 - 2 x PH2 - PH3
4 x		PZ1 - 2 x PZ2 - PZ3
4 x		3 - 4 - 5 - 6 mm
7 x		T10 - T15 - T20 - T25 - T27 - T30 - T40
7 x		TB10 - TB15 - TB20 - TB25 - TB27 - TB30 - TB40

+30%

lässt sich an die 18V eMONSTER Geräte als Akku-Dummy anstecken und arretieren

# HIER GEHT'S SCHLAG AUF SCHLAG!

**1.390 N·m**

1/2"



515.1150

**199,90**

**1.390 N·m**

1/2"



515.1270

**149,90**

**1.084 N·m**

1/2"



515.1315

**69,90**

**1.600 N·m**

1/2"



515.1200

**69,90**

**2.000 N·m**

3/4"



515.3400

**124,90**

**1.690 N·m**

1/2" 3/4"



515.1210

**149,90**

515.3785

**189,90**

**3.405 N·m**

3/4" 1"



515.3250

**849,90**

515.3270

**849,90**

**3.405 N·m**

3/4" 1"



515.3260

**904,90**

515.3280

**904,90**

		Nm	U/min	m/s²	dB(A)	dB(A)	U/min	FT				
1	515.1150	1390	10.000	+9,18	100,0	113,0	190	1/2"	-	✓	-	1,0
2	515.1270	1390	10.000	+9,18	100,0	113,0	190	1/2"	-	✓	-	1,0
3	515.1315	1084	9000	+10,26	100,0	113,0	180	1/2"	-	✓	-	1,2
4	515.1200	1600	9000	+11,3	99,9	100,9	189	1/2"	✓	-	-	2,1
5	515.3400	2000	8500	+12,28	91,0	100,0	194	3/4"	✓	-	-	2,2
6	515.1210	1690	17000	+11,9	87,0	98,0	170	1/2"	✓	-	-	2,1
7	515.3785	1690	29000	+13,56	88,0	106,0	170	1/2"	✓	-	-	2,2
8	515.3250	3405	8000	+12,87	119,0	130,0	244	3/4"	✓	-	✓	1,4
9	515.3260	3405	8000	+12,51	118,0	124,0	244	3/4"	✓	-	-	1,4
10	515.3270	3405	8000	+12,28	118,0	124,0	244	3/4"	✓	-	-	1,2
11	515.3270	3405	8000	+12,57	119,0	124,0	244	1"	✓	-	-	1,2
12	515.3280	3405	10000	+12,01	115,0	124,0	244	1"	✓	-	-	2,4





**i** **Weitere Informationen**

**Fettförderung: Je ein Hub pro Abzugsbetätigung**

**66,50**

200 mm  
400 g  
400 mm

**515.3900 Druckluft-Fettpresse für hubweise Fettförderung**

**i** **Weitere Informationen**

**ab 24,90**

**PU** ✓

	0		
515.3330	6,0 mm	G1/4" AG	8,0 m 24,90 €
515.3335	8,0 mm	G1/4" AG	15,0 m 34,90 €
515.3340	10,0 mm	G3/8" AG	15,0 m 39,90 €

**515.3330 6,0 mm G1/4" AG 8,0 m 24,90 €**  
**515.3335 8,0 mm G1/4" AG 15,0 m 34,90 €**  
**515.3340 10,0 mm G3/8" AG 15,0 m 39,90 €**

**i** **Weitere Informationen**

**9,90**

regulierbar

100 mm

**515.1901 Druckluft-Ausblaspistole mit Durchflussregulierung**

**i** **Weitere Informationen**

**19,90**

510 mm  
330 mm  
95 mm

**515.1921 Druckluft-Ausblaspistolen-Satz**

**Automatischer Druckluftschlauch-Aufroller**

15 m  
1,5 m

**515.3440**

**515.3445**

180°

**STOP**

**i** **Weitere Informationen**

**119,90**

**Ø 10 MM X 15 M**

**A**

**Technische Daten:**  
 Schlauchinnendurchmesser: 10,0 mm  
 max. Druck: 20,0 bar  
 Anschlussgewinde: 1/4"

**515.3440**

**i** **Weitere Informationen**

**179,90**

**Ø 13 MM X 15 M**

**B**

**Technische Daten:**  
 Schlauchinnendurchmesser: 13,0 mm  
 max. Druck: 20,0 bar  
 Anschlussgewinde: 3/8"

**515.3445**

**i** **1**  
Weitere Informationen

**ab**  
**11,90**

A	500.8040	480 mm	11,90 €
B	500.8045	1.150 mm	39,90 €

**i** **1**  
Weitere Informationen

**1**  
**49,90**

500.8020

**i** **1**  
Weitere Informationen

**2**  
**59,90**

500.8030

**i** **1**  
Weitere Informationen

**HOCHBELASTBAR MIT 135 KG**

**3**  
**69,90**

500.8004

**i** **1**  
Weitere Informationen

**4**  
**69,90**

500.8011

**i** **1**  
Weitere Informationen

**6**  
**99,90**

500.8000

	<b>1</b>	<b>2</b>	<b>3</b>	<b>4</b>	<b>5</b>	<b>6</b>
Technische Daten:	500.8020	500.8030	500.8004	500.8011	500.8090	500.8000
Farbe	rot	rot	rot	rot	rot	rot
Material	Stahlrohr	Metall	Metall	Metall	Kunststoff	Metall
Anzahl Lenkrollen	4	5	5	6	6	6
rollbar	✓	✓	✓	✓	✓	✓
Art der Bereifung	Kunststoff	Kunststoff	Gummi	Kunststoff	Kunststoff	Kunststoff
gepolstert	✓	✓	✓	✓	✗	✓
höhenverstellbar	✗	✓	✓	✓	✗	✓
Verpackungsinhalt	1	1	1	1	1	1
Gesamtlänge L in mm	365,0 mm	370,0 mm	360,0 mm	1040,0 mm	1030,0 mm	1200,0 mm
Breite B	360,0 mm	370,0 mm	360,0 mm	490,0 mm	480,0 mm	420,0 mm
Höhe H	360,0 mm	420,0 - 540,0 mm	463,0 - 580,0 mm	85,0 - 400,0 mm	115,0 mm	145,0 - 510,0 mm
Gesamttragkraft kg	90 kg	90 kg	135 kg	90 kg	120 kg	90 kg

**i** **1**  
Weitere Informationen

**DIE LEICHTESTE**

**5**  
**67,90**

500.8090

**i**  **3**  
 Weitere Informationen

**Genial flexibel**

**NEU**

**44,90**

500.8077 **Werkzeugablagensatz aus Silikon**

1 53 x 29,5 x 3,2 cm

2 25,5 x 23,3 x 2,4 cm

3 27,5 x 14,5 x 2,4 cm

**i**  **1**  
 Weitere Informationen

- mit rutschfestem Profil auf der Laufbühne
- mit großer Plattform für sicheren Stand
- Kunststoffkanten an Füßen schützen Laufbühne und den Boden

**99,90**

800.0960 **Aluminium-Sicherheits-Laufbühne**

300 mm

960 mm

495 mm

**FÜR IHRE SICHERHEIT TÜV SÜD GEPRÜFT!**

**i**  **1**  
 Weitere Informationen

- mit Riffelblech-Profil auf der Trittstufe
- kein Kippen durch schräg gestellte Standfüße
- zusammenklappbar und dadurch platzsparend zu verstauen

**54,90**

800.0965 **Aluminium-Stufen-Stehleiter**

600 mm

440 mm

620 mm

**FÜR IHRE SICHERHEIT TÜV SÜD GEPRÜFT!**



1  
Weitere Informationen

**MAXIMALE ARBEITSFLÄCHE**

**1199,90**





865.0201 **XXL-Werkbank mit 3 Schubladen und 1 Tür**



1  
Weitere Informationen

**KLEIN UND GROSS ZUGLEICH!**

**179,90**





500.8100 **Universal Teleskop-Mehrzweckwagen mit Rollen**



1  
Weitere Informationen

**NEU**

**49,90**



**EXTREM LEISE  
ULTRALEICHT  
< 3,5 KG**

999.2000 **Werkstattventilator, 70 Watt**



1  
Weitere Informationen

**Parallel-Schraubstock**

**ab 165,90**



**Backen und Amboss induktiv gehärtet**

914.0004	120 mm	4"	165,90 €
914.0005	140 mm	5"	178,90 €
914.0006	160 mm	6"	189,90 €
914.0008	200 mm	8"	229,90 €

**i**

Weitere Informationen

 max. 8 bar (116 PSI)	 60° C 140° F
-----------------------------	---------------------

19,90

1 Water  
Max. 40° C  
Max.

2 Detergent

3

4

5

Switch

Lock

150.8271

**Druck-Pump-Schaum-Sprüher (Schäumer)**

**i**

Weitere Informationen

84,90

350 mm

650 mm

500.8013

**Fahrbarer Hocker**

**i**

Weitere Informationen

 6,3 L/s	 96 L/min
 32 m/s	 1/4" Ø

39,90

145 mm

3/8" - Ø 10 mm

saugen

pusten

515.5090

**Druckluft-Saug-Blaspistole**

**i** **1**  
Weitere Informationen

Ø 90 mm

M8

15 mm

**5,90**

515.1243 **Folienradierer**



**i** **1**  
Weitere Informationen

24 mm

Ø 100 mm

M8

**15,90**

515.1247 **Folienradierer mit Lamellen**

**i** **6**  
Weitere Informationen

**SETPREIS = 6x**

515.1285

**29,90**



**i** **6**  
Weitere Informationen

**SETPREIS = 6x**

515.1366

**89,90**

**i** **1**  
Weitere Informationen

**141,90**

515.1980 **Druckluft-Reinigungs-Pistole**

regulierbar

ON - OFF

Industriekugellager

**OPTIONAL**

**i** **1**  
Weitere Informationen

515.1983 **Bürsten-Aufsatz**

**5,90**

**i** **1**  
Weitere Informationen

515.1986 **Bürsten-Pinsel**

**5,90**

**i** **6**  
Weitere Informationen

**29,90**

510 mm

4 mm  
8 mm  
10 mm

4 mm  
8 mm  
10 mm

245 mm

**140.2370 Clip-Löse-Satz**

**i** **11**  
Weitere Informationen

**19,90**

180 mm 200 mm 200 mm 200 mm 210 mm

160 mm 200 mm 200 mm 180 mm 200 mm 200 mm

**911.8205 MASTER Kunststoffkeil-Satz**

**i** **1**   
Weitere Informationen

**79,90**

- beseitigt Gerüche und desinfiziert den Fahrzeuginnenraum
- automatische Abschaltung im Geruchs- beseitigungs-Modus nach 60 Minuten
- arbeitet ohne chemische Zusätze, daher ist eine rückstandslose Reinigung garantiert
- hinterlässt selbst auf empfindlichen Oberflächen keine Spuren
- beseitigt Schimmel, Bakterien, Pilze und Milben

173 mm

49 mm

122 mm

**550.1183 Plasma-Luftreiniger mit Ionisator-Technik**

**i** **1**  
Weitere Informationen

- ideal geeignet zum Reinigen von engen Rohren, Schläuchen oder Abflüssen
- doppelseitig verwendbar
- flexibler Edelstahlschaft
- Nylonborsten

**3,90 NEU**

Ø 16 mm

Ø 22 mm

**150.1762 Flexible Reinigungsbürste**

**i** **7**  
Weitere Informationen

**79,90**

Ø 0 - 38 mm

Ø 0 - 48,5 mm

Ø 0 - 65 mm

Ø 0 - 30 mm

Ø 0 - 45 mm

Ø 0 - 45 mm

Ø 0 - 60 mm

**115.1055 KFZ Schlauchschellenzangen-Satz**



**i** **3**  
Weitere Informationen

**9,90**

Ø 15 mm    Ø 30 mm    Ø 60 mm

150 mm    180 mm    250 mm

115.5050

**i** **3**  
Weitere Informationen

Ø 15 mm    Ø 35 mm    Ø 23 mm

155 mm    255 mm    165 mm

115.5055

**12,90**

**i** **1**  
Weitere Informationen

**14,90**

Absaug- und Füllhandpumpe

150.9221

**i** **1**  
Weitere Informationen

**19,90**

3/8" Spezial-Steckschlüssel für Saugrohr-Verschraubungen

100 mm

150.2519

**i** **1**  
Weitere Informationen

**19,90**

Elektrische Öl-Absaug- und Umfüllpumpe

12V 5A 60W  
Richtung Direction  
150.2820

12,0 V

PETROL DIESEL OIL

150.2820

**i** **1**  
Weitere Informationen

Wechselnuss für 30-45 mm und 60-80 mm Schlauchschellen

**4,90**

**NEU**

30 mm

115.0915

**2 in 1 Spezial-Steckschlüssel für Schlauchschellen mit 3-Punkt-Profil**

**i** **1**  
Weitere Informationen

**12,90**

**NEU**

1/2"

108 mm

150.1919

**Kühlerdeckel-Lösewerkzeug für VAG**



25



Weitere Informationen



0 - 2,5 bar



max. 76 cm

0 - 200 °C  
0 - 400 °F

1600 mm



R123  
R124

R123  
R125

#1

#2

#3

M50 x 2,5

M42 x 3



M58 x 3

M62 x 3

M48 x 4

M45 x 3

M50 x 2,5

M60 x 4

M52 x 3



M48 x 2,5

M42 x 2,5

M50 x 3

M46 x 3

M34 x 2,5

75 mm



# 179,90

MASTER

Kühlsystem-Diagnose-Service-Satz

150.1930



1

Kupplung 7,2 mm auf 4,4 mm

Weitere Informationen



7,2 mm

80 mm

4,4 mm

# 19,90

150.1936



1

Kupplung 4,4 mm auf 7,2 mm

Weitere Informationen



4,4 mm

74 mm

7,2 mm

# 24,90

150.1937

**i** **8**  
 Weitere Informationen

250 ml



**99,90**



OPTIONAL ZUM NACHKAUF  
**14,90**  
 150.1914



150.1910 CO2-Zylinderkopf-Lecktest-Satz

**GENIAL FLEXIBEL**

**i** **3**  
 Weitere Informationen

53 x 29,5 x 3,2 cm

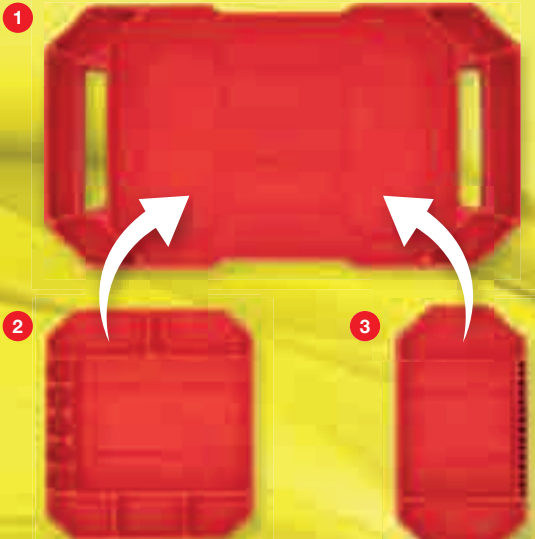

25,5 x 23,3 x 2,4 cm

27,5 x 14,5 x 2,4 cm

**NEU**

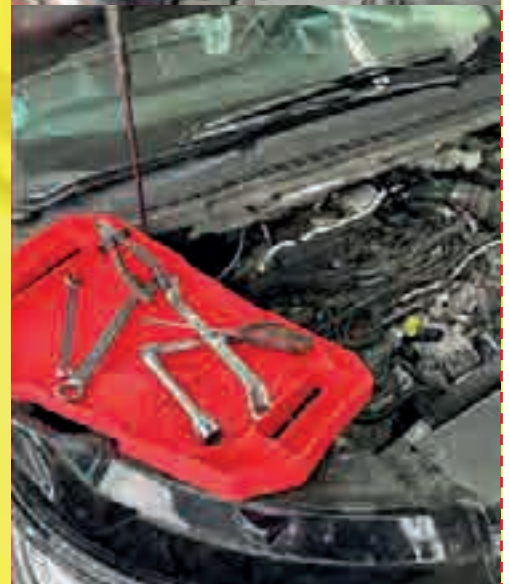

**44,90**

500.8077 Werkzeugablagensatz aus Silikon



**2**  
Weitere Informationen



**EcoBoost**

# 24,90

**NEU**



14 mm

+



16 mm

**FÜR FORD ECOBOOST MOTOREN 1,0 LITER**

**FÜR FORD ECOBOOST MOTOREN 1,5 LITER**



517.1135



**Zündkerzen-Stecknuss-Satz für EcoBoost Motoren**



**2**  
Weitere Informationen



13 mm

M20 x 1.5



+

M22 x 1.5



27 mm

mit 6 Schneiden für ideale Zentrierung

mit Reinigungsnuten im Führungsbolzen

# 179,90

150.2540

**Gewindeschneider-Satz mit Führungsbolzen für Sensoren**

## GENIALE PROBLEMLÖSER



**1**  
Weitere Informationen



13 mm

**Gewindeschneider mit Führungsbolzen**

- zum Nachschneiden verrosteter und beschädigter Sondengewinde

**A**



**B**



**C**



**D**



**E**



mit 6 Schneiden für ideale Zentrierung

mit Reinigungsnuten im Führungsbolzen

# 99,90

			L1	L2			
<b>A</b>	150.2541	für Temperatursensoren	M12 x 1,25	55 mm	33 mm	13 mm	99,90 €
<b>B</b>	150.2542	für Temperatursensoren	M14 x 1,5	45 mm	30 mm	13 mm	99,90 €
<b>C</b>	150.2543	für Lambdasonden	M18 x 1,5	42 mm	27 mm	13 mm	99,90 €
<b>D</b>	150.2544	für NOX-Sensoren	M20 x 1,5	50 mm	27 mm	13 mm	99,90 €
<b>E</b>	150.2546	für Partikelfiltersensoren	M22 x 1,5	50 mm	27 mm	13 mm	99,90 €

**i**  **1**  
 Weitere Informationen

**19,90**



**1** **2**

**Zündspulen-Abzieher für Stab-Zündspulen**

**500.7505**



**i**  **7**  
 Weitere Informationen

**FÜR VAG UND OPEL MOTOREN**

**69,90**



**1** **2** **3** **4** **5** **6** **7**

**T-Griff-Zündspulen-Abzieher-Satz für VAG und Opel Motoren**

**500.7570**







**i**  **7**  
 Weitere Informationen

**120 ml** **120 ml**



**6x10**  
**6x6**  
**6x8**  
**6x4**  
**600 mm**  
**Ø 6x9 mm**

**169,90**

**Druck- und Unterdruck-pumpen-Satz**

**150.1900**



**i**  **24**  
 Weitere Informationen



**49,90**

**Universal Wellendichtring und Simmerring Montagewerkzeug-Satz**

**700.1280**



**i** **Weitere Informationen**

**39,90**

**150.3170 Universal-Rillen-Riemenscheiben-Abzieher Ø 40-165 mm**

**i** **Weitere Informationen**

**NEU**

- zum Spannen und Entspannen der Zahnriemen-Spannrolle
- verstellbar, universal einsetzbar
- Innenvierkantantrieb nach DIN 3120 / ISO 1174
- mit Außensechskantantrieb 13,0 mm
- phosphatiert

**19,90**

**150.3046 Universal-Zapfenschlüssel für Zahnriemen-Spannrolle, verstellbar**

**i** **Weitere Informationen**

Anwendungsgebiete: Citroën, Peugeot, Opel und Toyota mit 1,0 und 1,2 Benzin-Motoren (Motorcode: ZMZ (EBOF / EBO) / HM01 (1PP) / HMV, HMZ (EB2) / HMZ (EB2 / EB2F) / HMT (EB2D) / HMU (EB2D) / HNZ (EB2DT) / HNY (EB2DTS) / HMV (EB2M) / HMY (EB2M) / B12XE (EB2F) / D12XE (EB2FA) / B12XHL (EB2DT) / D12XHL, F12XHL (EB2ADT) / B12XHT (EB2DTS) / D12XHT, F12XHT (EB2ADTS))

**9,90**

**400.2118 Zahnriemen-Prüfwerkzeug für PSA**

**i** **Weitere Informationen**

**34,90**

**150.3130 Universal-Riemenscheiben-Abzieher 3-armig**

**i** **Weitere Informationen**

- für die Montage und Demontage der schwer zu öffnenden CLIC-Federverschluß-Leitungskupplungen bei Kraftstoff-, Klimaanlage-, Luft- und Hydraulikleitungen
- keine Beschädigung der Steckkupplungen, Kraftstoffleitungen und Kraftstoffschläuche
- schnelles und einfaches Trennen der Kraftstoffleitungen
- für nahezu alle Leitungskupplungen an europäischen, asiatischen und amerikanischen Fahrzeugen

**115.1260 Leitungsverbinder-Entrieglungs-Satz**

**49,90**

5/16"	1/4"	5/16"	3/8"	3/8"	1/2"	5/8"	7/8"
3/8"	1/2"	5/8"	3/4"	5/16"			
3/8"	1/2"	5/8"					
3/4"	7/8"	5/16" x 3/8"					
							5/16"

# MIT 3.873 SCHLÄGEN PRO MINUTE ZIEHT ER JEDEN AUS!

**NEU**

- inklusive 7 Adaptern für nahezu alle Injektoren
- enorm hohe Schlagwirkung (3365 (6,3 bar) / 3873 (8 bar) Schläge pro Minute)
- zum Ausbau der festgebrannten Injektoren im Zylinderkopf
- mit einem entsprechenden Adapter wird der Auszieher an der festsitzenden Einspritzdüse verschraubt
- geringer Platzbedarf durch kompakte Bauweise



**A B C**



**D**



**E F G H**



223 Liter	3/4" - 19 mm	108,4 mm
6,3 bar (90 psi)	71,9 mm	6 mm
12 bar	119,4 mm	M18 x 1,5

<b>A</b>	M25 x 1,0	Siemens
<b>B</b>	M20 x 1,0	Denso
<b>C</b>	M27 x 1,0	Siemens
<b>D</b>	M27/M17/ 10 mm	Bosch/Fiat/BMW/PSA/ Mercedes/Renault
<b>E</b>	M18 x 1,5	Adapter
<b>F</b>	M17 x 1,0	Bosch/Mercedes
<b>G</b>	M16 x 1,0	Toyota
<b>H</b>	M14 x 1,5	Bosch/Delphi/BMW

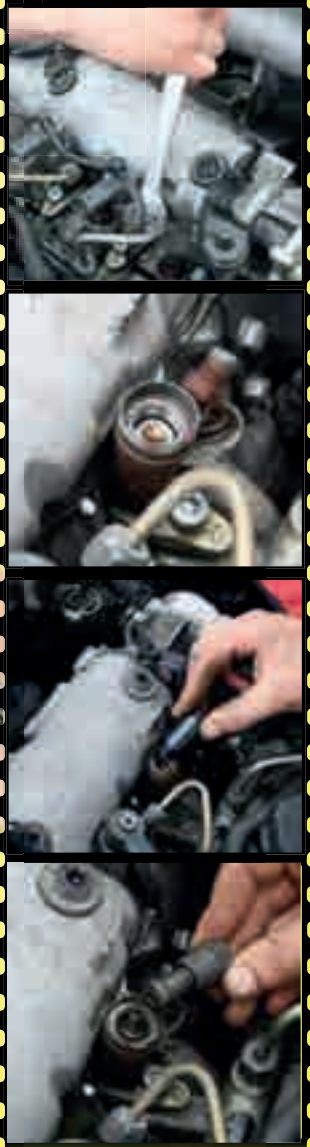

**BOSCH** ✓  
**DENSO** ✓  
**DELPHI** ✓  
**SIEMENS** ✓

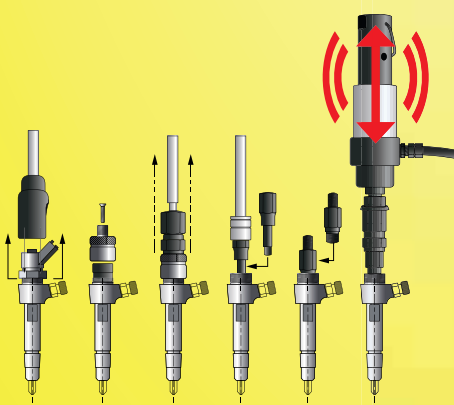

**269,90**

**6**  
Weitere Informationen

285 - 875 mm  
**TELESKOPIERBAR**  
150 - 675 mm

500g  
200g  
1000g  
2000g  
3000g

Ø 4 mm  
Ø 13 mm  
Ø 16 mm  
Ø 19 mm

400 mm  
510 mm

**NEU**

**26,90**

550.1090 **Flexibler und teleskopierbarer Magnethalter und Inspektionsspiegel-Satz**

**1**  
Weitere Informationen

125 mm

6 - 24 V

**4,90**

550.1504 **Prüflampe 6 - 24 V**

**1**  
Weitere Informationen

11,90

3 - 48 V

550.1503 **Polaritäts- und Spannungsprüfer 3 - 48 V**

**2**  
Weitere Informationen

129,90

25 m

6 - 24 V

150.1655 **Funktionsprüflampe**

**2**  
Weitere Informationen

1 Empfänger

2 Sender mit Krokodilklemmen

**59,90**

150.3075 **Gleichstrom-Kurzschlussdetektor**



**i**

Weitere Informationen

Batterie laden  
 Erhaltungsladen  
 Reparatur der Batterie  
 Gleichstromversorgung  
 umschaltbar zwischen 12 und 24 Volt

# 369,90

Temperatursensor

**Technische Daten:**

Batteriekapazität:	12V: 75-500Ah - 24V: 45-250Ah
Spannungsbereich:	220-240V AC, 50/60HZ
Ladespannung:	14,4V - 25A (12V), 28,8V - 12,5A (24V)
Frequenzbereich:	50 Hz
Leitung:	H05RN-F 2x1,0 mm <sup>2</sup>

550.1745 **12V + 24V SMARTcharger Hochfrequenz-Batterieladegerät 25A/12,5A**

**i**

Weitere Informationen

# 367,90

Für fast alle Batterien

Mit Drucker und 3 Rollen Papier

**Technische Daten:**

Anzeige:	digital
Arbeitsbereich CA / MCA:	40-2.000 CCA
Arbeitsbereich CCA:	40-2.000 CCA
Arbeitsbereich DIN:	40-2.000 CCA
Arbeitsbereich EN:	40-2.000 CCA
Arbeitsbereich IEC:	40-2.000 CCA
Arbeitsbereich JIS#:	40-2.000 CCA
Arbeitsbereich SAE:	40-2.000 CCA
Arbeitstemperatur:	0°C bis +55°C
Frequenzbereich:	100 Hz
Messbereich:	9-36 V
Messgenauigkeit:	+/- 0,5 Megaohm
Spannungsbereich:	9-36 V

550.1649 **12V / 24V Digital-Batterie- und Ladesystemtester mit integriertem Drucker**

**i**

Weitere Informationen

# 599,90

1.400 A

**SAFETY Xtreme**

Intelligentes Sicherheitskonzept vermeidet Anwender-Fehler:

Sicherheitsschaltung gibt erst Strom auf die Klemmen wenn:

- korrekt angeschlossen wurde (Polung)
- die Verbindung kurzschlussicher ist
- die richtige Spannung anliegt
- die Fahrzeugbatterie in Ordnung ist

550.1720 **12 V + 24 V Batterie-Booster - mobiles Starthilfegerät 1400 A**



**26**  
Weitere Informationen



1000 V





**3/8"**

**329,90**

Werkzeugsatz mit isolierten Werkzeugen für Hybrid- und Elektrofahrzeuge

117.1895



2 x		4 mm - 5,5 mm
2 x		PH1 - PH2
6 x		6 - 8 - 10 - 12 - 13 - 17 mm
1 x		185 mm
1 x		165 mm
1 x		3/8"
1 x		3/8": 200 mm
1 x		3/8": 125 mm
10 x		3/8": 8 - 10 - 11 - 12 - 13 - 14 - 16 - 17 - 19 - 22 mm
1 x		200 mm



**43**  
Weitere Informationen



1000 V











**3/8"**

**564,90**

Isolierter Werkzeug-Satz für Hybrid- und Elektrofahrzeuge

117.1890

4 x		2,5 - 3 - 3,5 - 4 mm
3 x		PH1 - PH2 - PH3
3 x		T20 - T25 - T30
1 x		210 mm
1 x		185 mm
1 x		165 mm
1 x		215 mm
1 x		165 mm
1 x		240 mm
2 x		10 - 25 mm
1 x		180 mm
1 x		3/8"
15 x		3/8": 6 - 7 - 8 - 9 - 10 - 11 - 12 - 13 - 14 - 16 - 17 - 18 - 19 - 20 - 22 mm
2 x		3/8": 150 - 250 mm
3 x		3/8": M8 - M10 - M12
1 x		Ø 200 mm
1 x		200 mm
1 x		500 m



**18**  
Weitere Informationen



1000 V







118.1500

18 x		7 - 8 - 9 - 10 - 11 - 12 - 13 - 14 - 15 - 16 - 17 - 18 - 19 - 20 - 21 - 22 - 23 - 24 mm
------	---------------------------------------------------------------------------------------	-----------------------------------------------------------------------------------------

329,90

Maulschlüssel-Satz mit Schutzisolierung



**1**  
Weitere Informationen





**<44.500 V**

1.680 mm

**179,90**

Isolierte Rettungsstange

150.0913



Weitere Informationen

# DER EINSTEIGER-SATZ IN DIE ELEKTROMOBILITÄT

## ecoLine



1



2,5 - 4 - 5,5 mm PH0 - PH1 - PH2



2

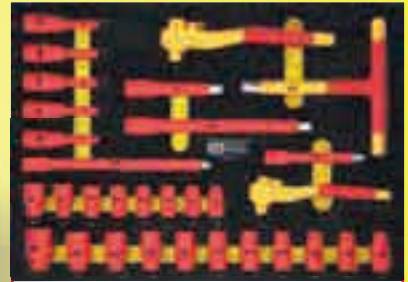

3/8" 8-18 mm 1/2" 10-24 mm 125+250 mm

125+250 mm 4-5-6-8-10 mm 3/8"+1/2"

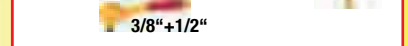

Vierkantlochung für Zubehörteile



verschießbar durch eingebautes Zylinderschloss



Arbeitsplatte mit 10 mm starker Schaumstoffeinlage



mit Selbsteinzug und SOFT-CLOSE-Funktion



2 x Roll- und Drehbremsen Ø Räder: 125 mm

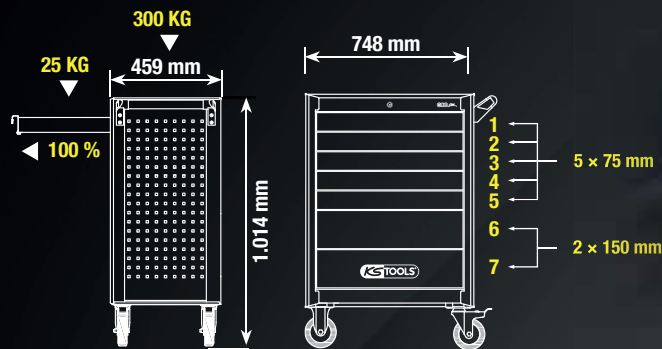

# 1299,00

## INKLUSIVE 42 WERKZEUGE

ECOline Werkstattwagen mit 42 isolierten Werkzeugen für Hybrid- und Elektrofahrzeuge

117.6144



**4299,00**



**117.6172** 3/8"-+1/2" Isolierter Steckschlüssel-Satz mit Drehmomentschlüssel in Schaumstoffeinlage, 72-tlg



**117.6133** Isolierte Schlüssel-Satz in Schaumstoffeinlage, 33-tlg



**117.6121** ERGOTORQUE VDE Schraubendreher-Satz in Schaumstoffeinlage, 21-tlg



**117.6117** ERGOTORQUE VDE Zangen-Satz in Schaumstoffeinlage, 17-tlg



**DER UMFANGREICHSTE SEINER KLASSE**

**117.6155** PERFORMANCEplus Werkstattwagen e10 mit 164 isolierten Werkzeugen für Hybrid- und Elektrofahrzeuge



**9,90**  
**117.0223** Dachaufsteller mit Blitzsymbol und Magnet

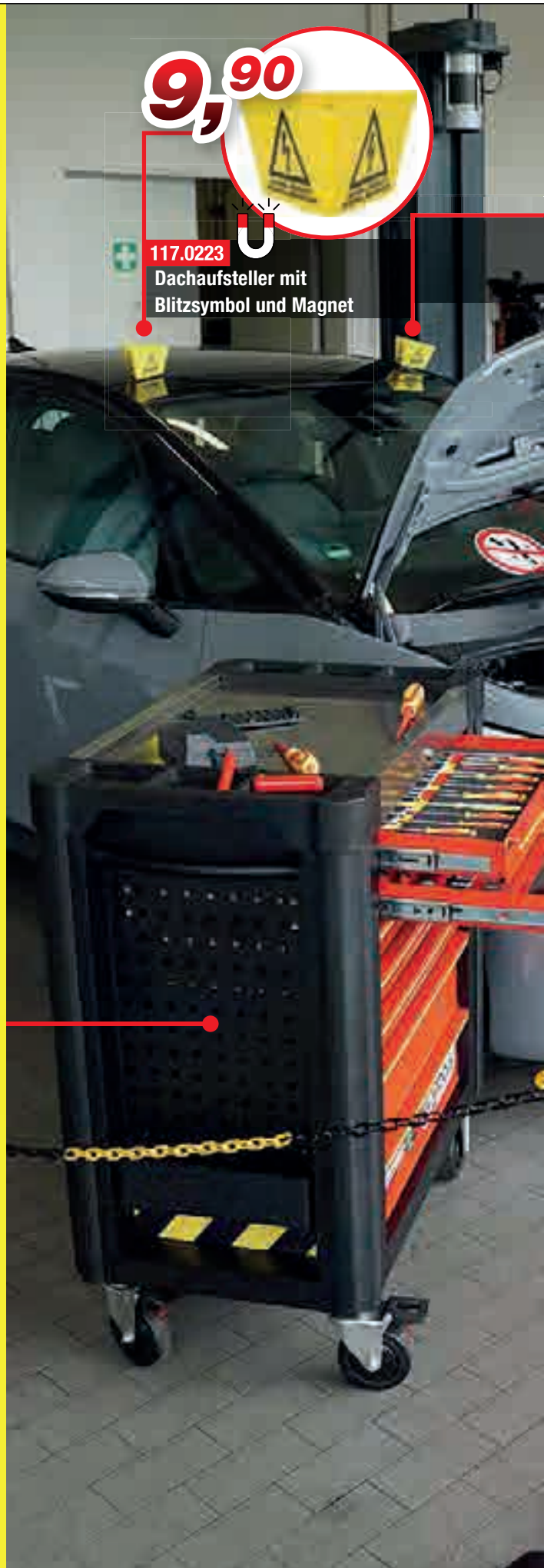

**9,90**

117.0222

Dachaufsteller mit Blitzsymbol und Saugnapf



**14,90**

117.0226

Aufsteller mit Blitzsymbol

**69,90**

117.1550

Absperrpfosten-Satz mit Kette

**2x**

**139,90**

117.1545  
2 x Scherensperre aus Kunststoff



Den Elektromobilitäts-Katalog mit 188 Seiten finden Sie unter [www.kstools.com](http://www.kstools.com)

**i** **4**  
 Weitere Informationen

Ø 22,0 - 28,0 mm

Ø 15,0 - 21,0 mm

Ø 17,0 - 25,0 mm

**Kupplungs-Zentrier-Werkzeug-Satz**

**8,90**

150.2180 Ø 15,0 - 28,0 mm

**i** **3**  
 Weitere Informationen

- 1 Füllwerkzeug A montieren und demontieren
- 2 Öl ablassen, geringer Durchfluss
- 3 Füllstand überprüfen
- 4 Öl ablassen, voller Durchfluss

**24,90**

**9G-TRONIC**

56 mm, 20 mm, 74,5 mm, 9 mm, 28,5 mm, 39,5 mm, 152 mm, 48 mm

150.9695

**i** **11**  
 Weitere Informationen

150 kg

310 mm, 450 mm, 300 mm

**394,90**

160.0910 **Universal-Getriebehalter-Satz**



**i** **24**  
 Weitere Informationen

**DER UMFANGREICHSTE!**

150.9261	1/8-27 NPT Ford
150.9262	BMW, Honda, Nissan etc.
150.9263	VAG
150.9264	VAG, Porsche
150.9265	M10 x 1,0 VAG, Mini Cooper
150.9267	M12 x 1,5 Mercedes
150.9268	M24 x 1,5 VAG DSG
150.9269	M22 x 1,5 VAG CVT
150.9271	M18 x 1,5 Skoda
150.9272	M30 x 1,5 VAG, Skoda
150.9273	Universal Flexible 300 mm, Honda, Hyundai, Kia, etc.
150.9274	5/16-24 (UNF) Volvo
150.9276	M18 x 1,5 Toyota / Lexus
150.9277	M8 x 1,0 Nissan / Infinity
150.9278	ATF-Adapter V.W, Passat
150.9562	Nissan Juke M12 x 1,25
150.9563	Mini Cooper M14 x 1,5
150.9564	Nissan M10 x 1,5
150.9566	GM M12 x 1,75
150.9567	Mercedes 725-9G
150.9102	VAG 7 DSG
150.9103	VAG 7 DSG
150.9104	VAG 7 DSG

**199,90**

**INKLUSIVE 23-TLG ADAPTERSATZ**

**NEU**

150.9105 **Universal Getriebeöl-Füllsystem-Satz inkl. 23-tlg Adaptersatz**

**i**  **4**  
 Weitere Informationen



**111,90**



**Ø 30 mm**

**McPherson Federbeinstütze für Getriebeheber**

160.0195

**i**  **7**  
 Weitere Informationen



6 mm

**99,90**





**Spezial Stoßdämpfer-Montagehilfe-Satz für Stoßdämpfer mit Zuganschlagfeder**

150.9545

**FÜR IHRE SICHERHEIT**



**GEPRÜFT!**

**i**  **6**  
 Weitere Informationen

universal für 90% aller gängigen Fahrzeugfedern im PKW und Transporterbereich



✓



Ø 80 - 160 mm

Ø 140 - 195 mm

**BELASTUNG max 26000 N**

**451,90**

**Universal Federspanner-Satz**

500.8400

Technische Daten:

Federdruck max.:	2600 kg
Spannweite max.:	355,0
Federkapazität:	80,0 - 195,0 mm

- ideal geeignet zur sicheren Montage und Demontage von Mc Pherson Federbeinen
- erforderlich beim Stoßdämpfer- oder Schraubenfederwechsel
- universal für 90% aller gängigen Fahrzeugfedern im PKW und Transporterbereich
- kostengünstige und solide Alternative zu gängigen Federspanner
- auch für konische - und Kugelfedern geeignet
- mit TÜV-Zulassung

# FÜR IHRE SICHERHEIT



# GEPRÜFT!

**i** **11**  
Weitere Informationen

**372,90**

1/2" x 1/2", 100 Nm  
Ø 30 mm

Ø 90 - 140 mm

**500.8765 Audi und Seat Teleskop-Centerspanner-Satz für innenliegende Federn**

ZUR ERWEITERUNG

**i** **2**  
Weitere Informationen

**FÜR FEDERSPANNER**  
**500.8755 + 500.8765**

Ø 95-110 mm

**99,90**

Anwendungsgebiete:  
Mercedes E-Klasse (W211 / W212), C-Klasse (W204), GLA (X156), GLK (X204),  
Ford Focus II (MK2), BMW 1er (E81), Volkswagen Passat (B8 / 36)

**500.8770 Paar-Federhalter Ø 95-110 mm**

ZUR ERWEITERUNG

**i** **9**  
Weitere Informationen

**338,90**

Ø 30 mm

Ø 90 - 140 mm      Ø 75 - 115 mm

**500.8755 Universal Teleskop-Centerspanner-Satz für innenliegende Federn**

WARNING - ACHTUNG - ADVARSEL  
ADVERTENCIA - AVERTISSEMENT



# FÜR 95% ALLER FAHRZEUGE



Weitere Informationen

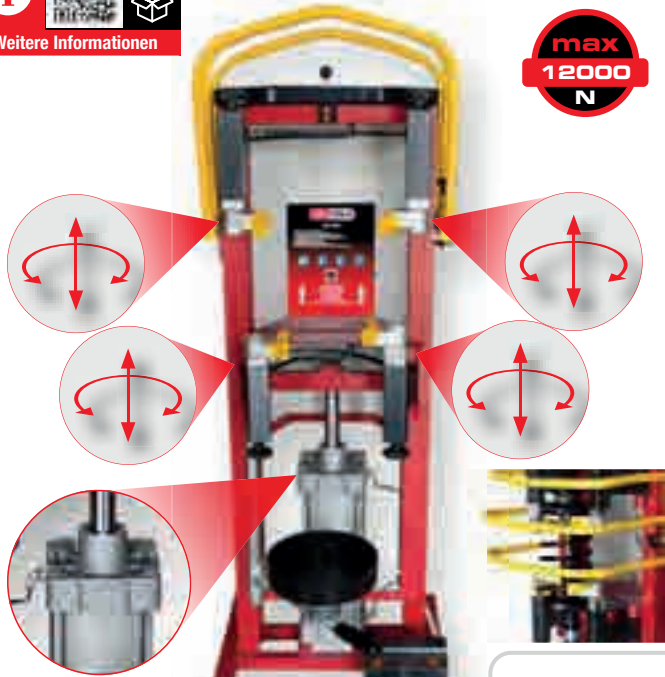

max  
12000  
N

**1149,00**

Druckluft-Stand-Federspanner,  
max. 10 bar

500.8800

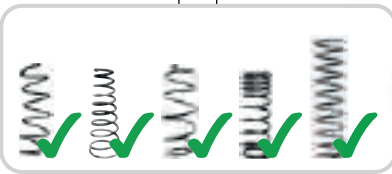

Weitere Informationen



max  
24000  
N

**1599,00**

Druckluft-Stand-Federspanner  
mit Doppel-Zylinder

500.8810

mit Doppel-  
Zylinder



Weitere Informationen



- einfache Handhabung
- Spezial-Werkzeugstahl
- ideal zur Aufnahme von Federbeinen
- optimal für sicheren Stand bei der Montage und Demontage
- mit 4 Fixierbolzen und 4 Gewindebolzen
- Lieferung erfolgt mit 2 Sprengringen zur Montage

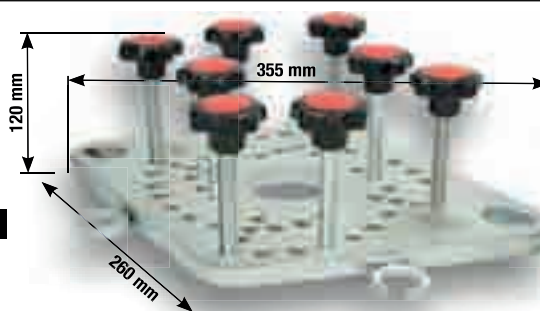

**281,90**



500.8801

Adapterplatte für Druckluft-Stand-Federspanner

## FEDERSPANNER-SATZ INKLUSIVE ADAPTERPLATTE



Weitere Informationen



Druckluft-Stand-  
Federspanner  
inkl. Adapterplatte

**1349,00**

500.8805



Weitere Informationen



Druckluft-Stand-  
Federspanner  
mit Doppel-Zylinder  
inkl. Adapterplatte

**1799,00**

500.8815

## KONFIGURIEREN SIE NACH IHREN WÜNSCHEN



440.9051



1199,<sup>90</sup>



GRÖßER ALS MAN DENKT

BREMSE



440.9087



2499,<sup>90</sup>

SILENTLAGER



440.9025

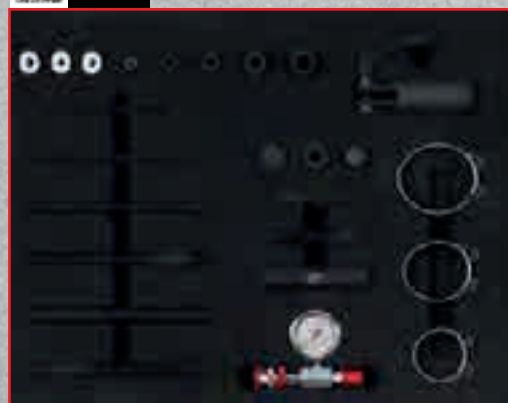

HYDRAULIKZYLINDER OHNE BETÄTIGUNGSWERKZEUGE

440.9161



3399,<sup>90</sup>

KOMPAKT-RADLAGER



440.9026

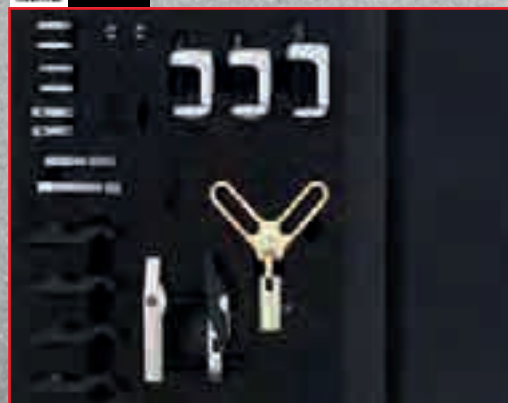

ACHSE

# HALBE LEBEN

# MODULO 2



Ø 155 mm



873.6008

**PERFORMANCEplus P40 SCHWARZ/ROT**  
Werkstattwagen mit 4 Schubladen

**2760,50**

**OHNE WERKZEUGE**

Weitere Informationen

2200 mm

**899,90**

Hydraulik-Pumpen-Satz  
mit Ablage für P40

440.9004

**999,90**



440.9076

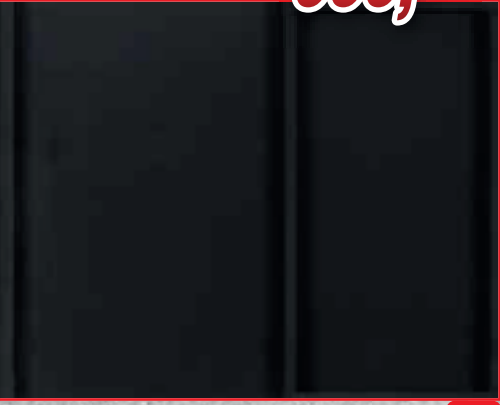

**1999,90**



**RADLAGER**



**799,90**



440.9061



**1899,90**



**STOSSDÄMPFER**



**i** **99,90**

Weitere Informationen

max. 8 bar

450 mm

1/4" PT

für Universal Achsmanschetten

**515.3100 Druckluftmontagegerät für Achsmanschetten**

**i** **49,90**

Weitere Informationen

100 mm

255 mm

Ø 30 mm

**515.1850 Universal Gelenkwellen-Abzieher**

**i** **39,90**

Weitere Informationen

VA FE

0 - 45 mm

270 mm

**115.1056 Schlauchklemmzange für Drehmomentanzug**

**i** **49,90**

Weitere Informationen

max. 12 mm

**ab 25,90**

Edelstahl-Kabelbinder mit Kugerverschluss

200 - 350 mm

115.1591			4,6 x 200 mm	25,90 €
115.1592			4,6 x 250 mm	25,90 €
115.1593			4,6 x 350 mm	28,90 €
115.1594			4,6 x 500 mm	37,90 €

**115.1590 Spannzange für Edelstahl-Kabelbinder mit Kugerverschluss**

**i** **39,90**

Weitere Informationen

UNIVERSAL

10 mm

**700.5662 Klemmbohrungs-Spreizwerkzeug**

**i** **1**  
Weitere Informationen

**24,<sup>90</sup>**

**Spezial Tragelenkstecknuss für Mercedes**

150.1721 Mercedes W167, W205, W213, W238, W253, W25

**i** **6**  
Weitere Informationen

**369,<sup>90</sup>**

**Vibro-Impact Druckluft-Meißelhammer-Satz**

515.3880

**VIPRO**

10 mm  
110 mm  
110 mm  
10 mm  
130 mm  
10 mm  
100 x 25 x 12 mm

37x / sec.

**i** **3**  
Weitere Informationen

**31,<sup>90</sup>**

**Klemmschrauben-  
Ausreiber-Satz**

700.5635

**i** **1**  
Weitere Informationen

**159,<sup>90</sup>**

**Vibro-Impact Lösewerkzeug für Spurstangen**

150.1608

- vibrationsunterstütztes Lösen von Spurstangen, Konterverschraubungen oder Verschraubungen im Achsenbereich etc.
- durch den speziellen Vibrationsdorn wird ein Schlagimpuls auf die zu lösende Verschraubung gegeben, dabei werden Anrostungen gelöst und der Lösevorgang unterstützt
- Druckluft-Meißeladapter (10 mm) für den Einsatz mit marktüblichen Druckluft-Meißel-Schlaghammer

27 mm  
290 mm  
10 mm  
65 mm



Weitere Informationen



168,90

700.1495 Universal-Achsheber mit Kette

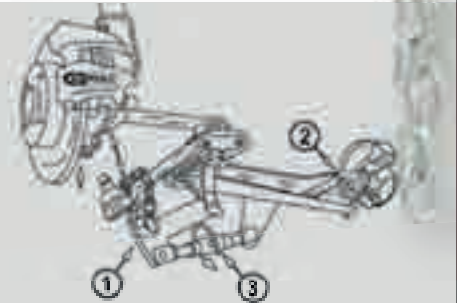

- durch flexible Kette lassen sich Querlenker unterschiedlichster Bauformen ohne großen Kraftaufwand sicher niederdrücken



Weitere Informationen

121,90

- stabile Trapez-Gewindespindel
- Fußpedal zur Feinjustierung (20mm)
- der ideale Werkstatthelfer in vielen Situationen

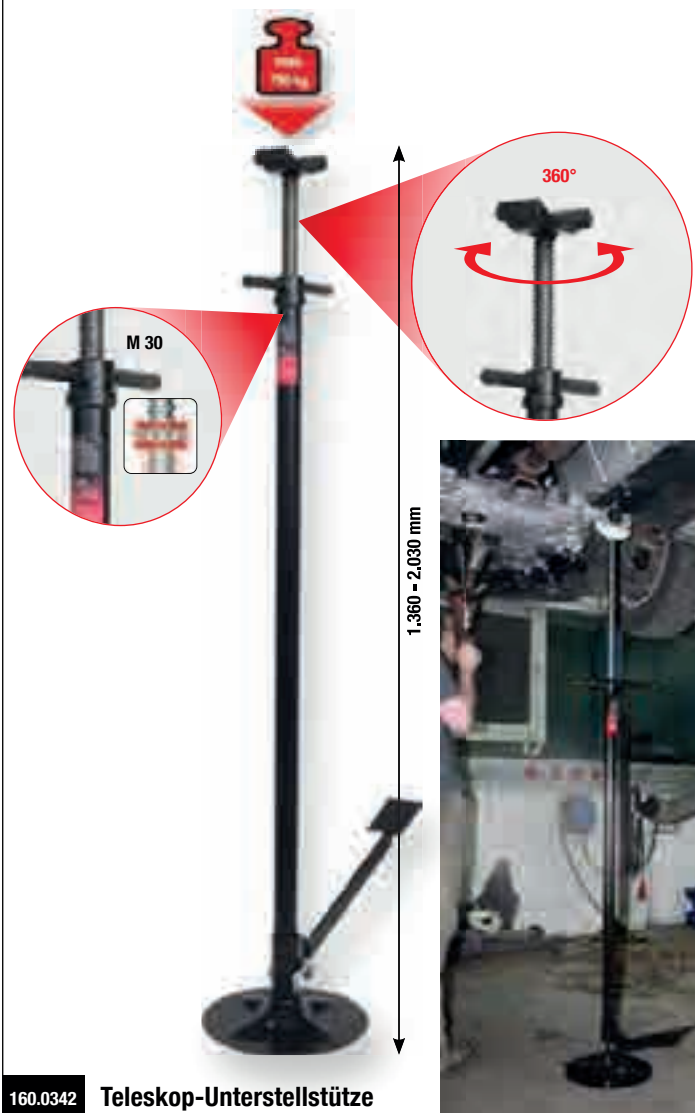

1.360 - 2.030 mm

360°

M 30

160.0342 Teleskop-Unterstellstütze



Weitere Informationen



20 mm

600 - 915 mm

89,90

911.8187 Teleskop Gelenk-Rollkopf-Hebeleisen



Weitere Informationen

99,90

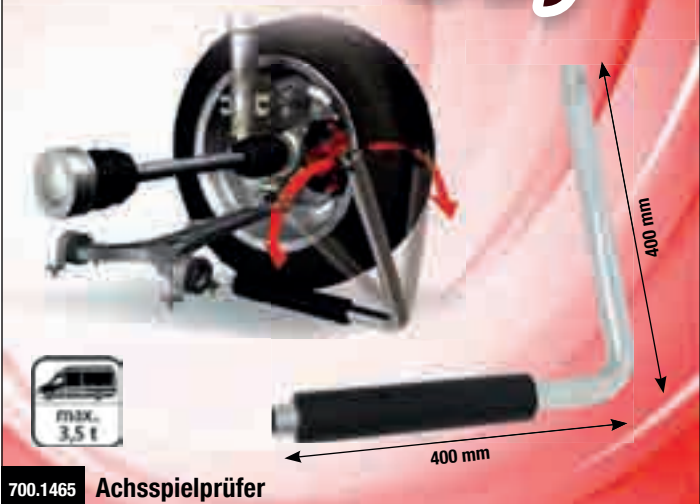

400 mm

400 mm

700.1465 Achsspielprüfer



Weitere Informationen

MIT SCHNELLVERRIEGELUNG



451,90

1000 W

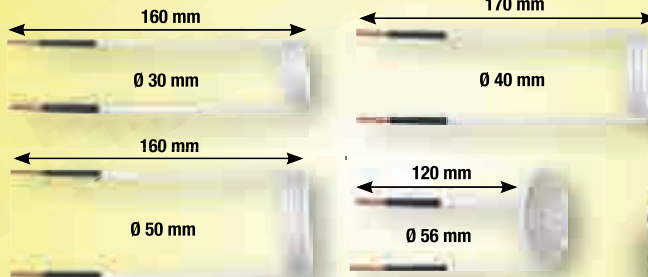

500.8605 Induktions-Heizpistolen-Satz



OPTIONAL ZUM NACHKAUF



129,90

500.8440

2. GENERATION - 2. GENERATION - 2. GENERATION - 2. GENERATION



Weitere Informationen

HAKEN DRAN!

NEU 14,90



Universal-Achshebel-Haken

700.1499

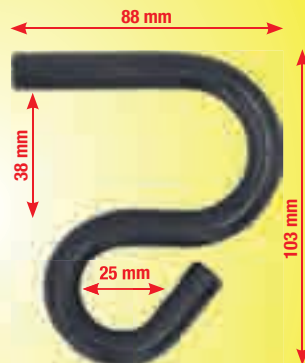

spezielle Form ermöglicht diesen sehr nah am Tragelenk anzusetzen

spezieller Hebel für die fachgerechte und schonende Montage und Demontage von Achsteilen



Weitere Informationen

- 1 x [Image]
- 2 x [Image]
- 9 x [Image]
- 13 x [Image]
- Ø1: 34 - 80 mm
- Ø2: 44 - 90 mm
- Ø 38 - 40 - 42 - 50 - 52  
54 - 62 - 64 - 66 mm
- Ø 34 - 36 - 44 - 46  
48 - 56 - 58 - 60 - 68  
70 - 72 - 75 - 80 mm
- 4 x [Image]
- M10x1,5  
M12x2,0  
M14x2,0  
M16x2,5



299,90

700.1550 Druck- und Zughülsen-Satz



**i** **22**

Weitere Informationen

Ø / mm

42 40 38 36 34 #1  
32 30 28 26 24 #2  
M12 #3  
M10 #4  
M12 M10 TR20

**700.2355 Stufen-Druckhülsen-Satz**

**499,90**



**i** **4**

Weitere Informationen

**79,90**

30-35 mm 35-40 mm 40-45 mm

360 mm

1/2" / 32 mm

**150.1125 Axialgelenk-Spezienschlüssel-Satz**



**i** **2**

Weitere Informationen

**M12**

**NEU**

115 mm

72 mm

**19,90**

**Spezial-Kraft-Bit-Stecknuss-Satz für Vielzahn(XZN®)-Schrauben**

**515.0595**

**i** **30**

Weitere Informationen

1 x Ø 90 - 130 mm

1 x

4 x M 14

4 x M12 x 1,25  
M12 x 1,5

4 x M12 x 1,25  
M12 x 1,5  
M14 x 1,5

3 ✓  
4 ✓  
5 ✓

1 x M18 x 2,5 x 230 mm

M57 x 2

**4,3 Kg**

**700.1530 Universal-Radnaben- und Gelenkwellen-Abzieher-Satz**

**224,90**



# WENIGER PERSONALEINSATZ, MEHR GEWINN.

## SCHEIBE AUSTRENNEN OHNE HELFER!

140.2630

### Universal Ein-Mann-Betrieb-Scheiben-Austrenngerät

- ideal für den fachgerechten und schonenden Ausbau von geklebten Windschutzscheiben sowie den meisten Heck- und Seitenscheiben
- mit großer Umlenkrolle, dadurch geringerer Kraftaufwand und Minimierung der Gefahr von Drahriss
- Drahtführung unmittelbar vor der Scheibe, dadurch entfällt in den meisten Fällen die aufwendige Demontage von Verkleidungsteilen
- leichte Bedienung durch Einmannbetrieb
- besonders hochwertige Pumpsauger für sicheren Halt auf der Scheibe



Weitere Informationen



ONE MAN CUT



Profi-Schutztafel-Satz, 4-tlg  
2x 270x200 mm + 2x 450x300 mm

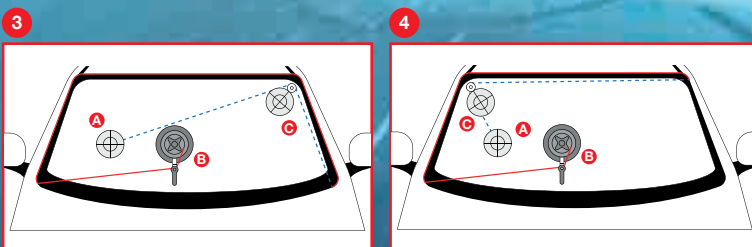
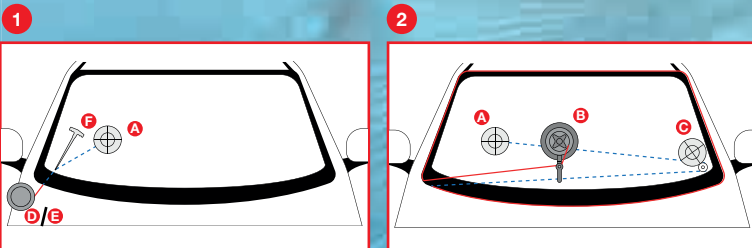
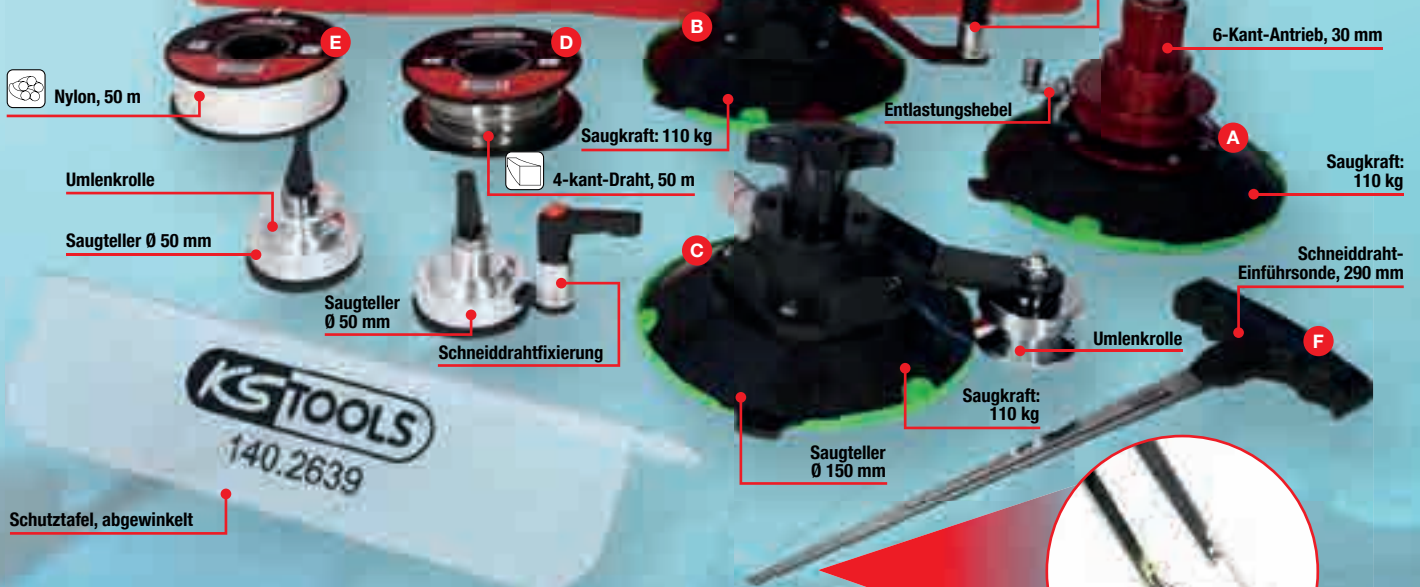

# 599,90

Inklusive



**NEU**

**1**  
Weitere Informationen

**AUCH FÜR DOT5.1, ENV4 UND ENV6**

- Dot3 ✓
- Dot4 ✓

0 20 mm

155 mm **14,90**

**Bremsflüssigkeitstester**

150.1969

**1**  
Weitere Informationen

**VITON® FKM**

**27,90**

**Pumpsprühflasche**

**Speziell für Bremsenreiniger**

150.8258

**2**  
Weitere Informationen

**10,90**

**Universal-Haken-Satz, formbar**

150.1935

**2**  
Weitere Informationen

**14,90**

**Universal-Haken-Satz, starr**

150.2235

**12**  
Weitere Informationen

**49,90**

**Bremsattelverschraubung-Spezialstecknuss-Satz**

150.2400

- 1/2" 11,5 mm 14 mm 15 mm 20 mm AS 22 mm
- 1/4" 9 x 20 mm
- 3/8" 7 x 72 mm 7 x 92 mm 9 x 50 mm 11 x 100 mm
- 3/8" 7 x 25 - 8 x 25 mm

**41**  
Weitere Informationen

**99,90**

**Bremskolben-Rückstell-Werkzeug-Satz**

150.1970



Weitere Informationen

# DAS UNIVERSAL-GENIE



**UNIVERSAL**  
Für 95% aller Fahrzeuge



2-pin

3-pin

3/8"

4-pin

# 129,90

150.2440 Universal Bremskolben-Rückstell-Werkzeug-Satz



Weitere Informationen

# 699,90



5L

160.0700 Bremsenwartungsgerät KS5



Weitere Informationen

# 49,90

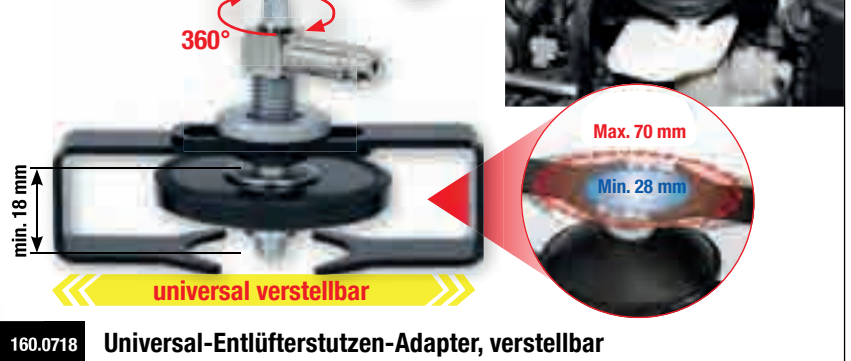

360°

min. 18 mm

Max. 70 mm

Min. 28 mm

universal verstellbar

160.0718 Universal-Entlüfterstutzen-Adapter, verstellbar



Weitere Informationen

# TOYOTA & LEXUS



7,2 mm

1 + 2

# 16,90

160.0719 Universal-Entlüfterstutzen-Adapter für Toyota und Lexus

**i** **6**  
Weitere Informationen

1.200 mm

**69,90**

**160.0725 Bremsen-Entlüftungsschlüssel-Satz**

11 mm  
10 mm  
9 mm  
8 mm  
7 mm

**STOP**

**i** **11**  
Weitere Informationen

**DER KOMPLETTE**

1.200 mm

9x12 mm

180 mm

**NEU**

11 mm  
10 mm  
11 mm  
7 mm  
11 mm  
10 mm  
11 mm  
86 mm

12 mm  
29 mm  
39 mm  
45 mm  
60 mm  
70 mm  
75 mm

**74,90**

**518.0320 Bremsen-Entlüftungs-Werkzeug-Satz für VAG**

**i** **1**  
Weitere Informationen

4,75 mm (3/16")

21 mm  
31 mm  
41 mm  
61 mm  
76 mm

**39,90**

**120.1006 Bremsleitungs-Biegewerkzeug**

**i** **1**  
Weitere Informationen

4,75 mm (3/16")  
6,35 mm (1/4")

**29,90**

**120.1004 Bremsleitungs-Richtwerkzeug / -Biegewerkzeug**

① Biegen  
② Duplizieren  
③ Richten

OUT IN

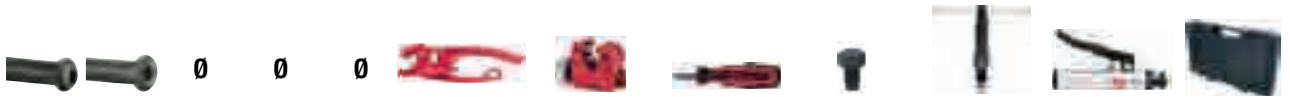

		DIN	SAE	4,75 mm	5,0 mm	6,0 mm	mit Rohrbieger	mit Rohrschneider	mit Rohrentgrater	mechanisch	mit Hydraulikspindel	Handpumpe	im Koffer
1	122.1215	✓	✗	✓	✗	✗	✗	✗	✗	✓	✗	✗	✗
2	122.1290	✓	✓	✓	✓	✓	✓	✓	✓	✗	✓	✗	✓
3	122.1260	✓	✓	✓	✓	✓	✗	✗	✗	✗	✗	✓	✓

4  
Weitere Informationen

4

49,<sup>90</sup>

1  
122.1215

**FLAREFIXeco 4,75 mm Universal-Bremsleitungs-Bördelgerät-Satz**

16  
Weitere Informationen

16

## FLAREFIX

DIN  
SAE

169,<sup>90</sup>

3,0-6,0 mm

4,75-5,0 mm, SAE

6,0 mm, SAE

4,75-5,0-6,0 mm, SAE-90°

4,75-5,0 mm, DIN

6,0 mm, DIN

M12x1,25

3,0-12,0 mm

3,0-16,0 mm

4,75 mm, 3/16"

5,0 mm

6,0 mm

2  
122.1290

**FLAREFIX 1 Universal-Bremsleitungs-Bördelgerät-Satz mit Hydraulik-Spindel**

HYDRAULISCH, PRAKTISCH, GUT!

11  
Weitere Informationen

11

## FLAREFIX II

### Hydraulic

M12 x 1,25 mm

4,75-5,0 mm, SAE

6,0 mm, SAE

4,75-5,0-6,0 mm, SAE-90°

4,75-5,0 mm, DIN

6,0 mm, DIN

M12x1,25

5,0 mm

4,75 mm, 3/16"

6,0 mm

DIN  
SAE

299,<sup>90</sup>

3  
122.1260

**FLAREFIX 2 Universal-Bremsleitungs-Bördelgerät-Satz mit Hydraulik-Zylinder**



Weitere Informationen

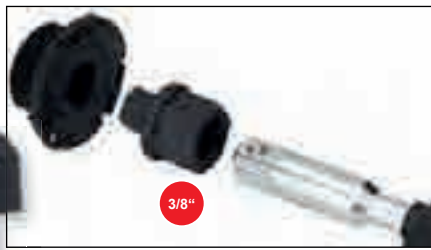

1 Ford/PSA



2 BMW



3 VAG



4 Mercedes



5 DAF/MAN



6 GM



7 Ford



8 Ford



9 Ford

**24,90**

3/8" Öldienst-Spezialprofil-Satz für Kunststoff-Ölablassschrauben, 9-tlg

150.1040



Weitere Informationen



**69,90**

- Werkzeug zum Planen des Dichtsitzes von Ölablassschrauben
- Planen des Dichtsitzes sichert einwandfreie Abdichtung im Bereich der Ölablassschraube
- exakte Zentrierung und Ausrichtung zur Dichtfläche
- Satz inklusive Adaption für Original-Ölablassschraube und Übermaß-Reparaturgewindeschraube
- in stabilem Kunststoffkoffer



0° / Ø 22



M14x1,5

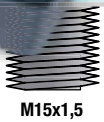

M15x1,5



150.1485

Ölablassschrauben-Dichtsitz-Planfräser-Satz



Weitere Informationen



**7,5 Liter**

Ø 385 mm

**12,90**

150.9359

Auffangwanne 7,5 Liter



**i**  **30**  
 Weitere Informationen

1/2" 21 mm  
 Ø 63 - 102 mm

**99,<sup>90</sup>**

**3/8" Ölfilterschlüssel-Satz**

65-14, 65/67-14, 66-6, 68-14, 73-14, 74-15, 74/76-15, 75/77-15, 76-8, 76-12, 76-14, 76-30, 78-15, 80-15, 80/82-15, 86-18, 86-16, 90-15, 92-10, 93-15, 93-36, 93-45, 95-15, 96-18, 100-15, 106-15, 108-15, 108-18



**i**  **24**  
 Weitere Informationen

2,0 L

**99,<sup>90</sup>**

VW Lexus Lotus Ford Nissan  
 Subaru Mitsubishi Land Rover Hyundai Audi  
 Chrysler Toyota Citroën Volvo Cadillac  
 Citroën Buick Volvo Buick universal

**MASTER Öl-Einfülltrichter-Satz mit drehbarem Winkelarm**



**i**  **4**  
 Weitere Informationen

**FÜR VAG**

mit drehbarem Winkelarm für schwer zugängliche Stellen

**14,<sup>90</sup>**

**Öl-Einfülltrichter-Satz mit drehbarem Winkelarm für VAG**

2,0 L



# AUF DIE BÜHNE - FERTIG - LOS!

aus Voll-Gummi

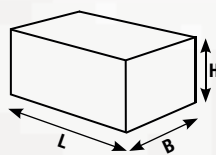

Weitere Informationen

Teile	L mm	B mm	H mm		
160.0476	1	160	120	20	4, <sup>90</sup> €
160.0477	1	160	120	30	6, <sup>90</sup> €
160.0478	1	160	120	40	8, <sup>90</sup> €
160.0479	1	160	120	60	12, <sup>90</sup> €
160.0480	1	160	120	80	16, <sup>90</sup> €
160.0481	1	160	120	100	20, <sup>90</sup> €
160.0482	1	160	120	115	23, <sup>90</sup> €
160.0483	1	116,5	116,5	36,5	5, <sup>90</sup> €
160.0499	1	160	120	85	17, <sup>90</sup> €

PE (Polyethylen)

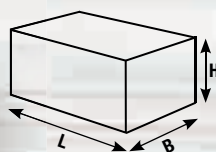

Weitere Informationen

Teile	L mm	B mm	H mm		
160.0437	1	250	150	55	14, <sup>90</sup> €
160.0438	1	250	150	100	26, <sup>90</sup> €
160.0486	1	340	150	55	19, <sup>90</sup> €
160.0489	1	340	130	100	31, <sup>90</sup> €



Weitere Informationen

aus Voll-Gummi mit verstärktem Kern

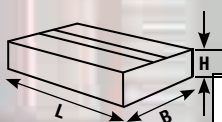

Teile	L mm	B mm	H mm		
160.0484	1	373	100	35	39, <sup>90</sup> €



Weitere Informationen

aus hochfestem Kunststoff

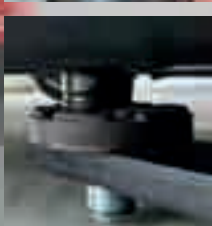

- Model 3 ✓
- Model S ✓
- Model X ✓
- Model Y ✓

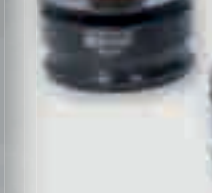
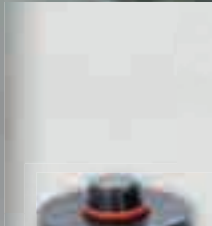

160.0460 Tesla Model 3, S, X, Y

**23,<sup>90</sup>**



Weitere Informationen

aus Voll-Gummi

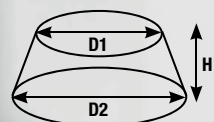

Teile	D1 mm	D2 mm	H mm		
160.0485	1	78	105	60	9, <sup>90</sup> €





## aus Gummi und Stahlplatte

Weitere Informationen

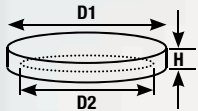

	D1 mm	D2 mm	H mm	Ravaglioli	Grazia	OMCN	Intertech	MAHA	Werther	Nussbaum	AMI	Twin Busch	Sirio	Space	Launch	RP Tools	J.A. Becker	ATH	HOFMANN	Hermann		
A	160.0463	120	113	22				✓														8,90 €
B	160.0465	123	108	25	✓				✓													8,90 €
C	160.0475	120	110	19													✓	✓	✓	✓		8,90 €



## aus Gummi

Weitere Informationen

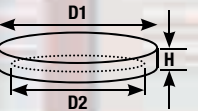

	D1 mm	D2 mm	H mm	Ravaglioli	Grazia	OMCN	Intertech	MAHA	Werther	Nussbaum	AMI	Twin Busch	Sirio	Space	Launch	RP Tools	J.A. Becker	ATH	HOFMANN	Hermann		
A	160.0466	125	120	24						✓	✓											11,90 €
B	160.0467	140	130	25								✓										5,90 €
C	160.0468	100	85	14	✓								✓	✓								4,90 €
D	160.0464	120	113	23				✓														4,90 €
E	160.0469	120	108	32								✓			✓	✓						7,90 €
F	160.0470	130	125	14	✓								✓	✓								4,90 €
G	160.0471	140	125	30								✓										7,90 €
H	160.0472	150	130	23	✓																	6,90 €
I	160.0473	120	105	30								✓										6,90 €
J	160.0474	120	110	19													✓	✓	✓	✓		4,90 €
K	160.0490	100	80	21	✓																	3,90 €
L	160.0491	120	108	26	✓	✓																4,90 €
M	160.0492	120	110	26	✓	✓																4,90 €
N	160.0493	145	108	24	✓		✓															7,90 €
O	160.0494	145	135	26	✓																	6,90 €
P	160.0495	160	135	28			✓															6,90 €
Q	160.0496	140	103	25						✓												7,90 €
R	160.0497	150	127	25	✓																	5,90 €
S	160.0498	140	132	28																		8,90 €

**i** **1**  
Weitere Informationen

**7,90**

**800.0156** Kunststoff-Magnet-Schale, Ø 150 mm

**i** **1**  
Weitere Informationen

**9,90**

**150.2032** Metall-Reifen-Ventilhebel, 330 mm

**i** **1**  
Weitere Informationen

**27,90**

**911.8135** Runflat Reifen- und Montagehebel

**i** **1**  
Weitere Informationen

**49,90**

**800.0190** Metall-Magnethalter, 390 mm

**i** **1**  
Weitere Informationen

**19,90**

**515.1950** Druckluft-Reifenfüllmesser

600 mm

0 - 12 bar

1/4" PT

**i** **1**  
Weitere Informationen

**GEEICHT**

**61,90**

**515.1960** Geeichter Druckluft-Reifenfüllmesser

400 mm

0 - 10 bar

1/4" PT

**i** **5**  
Weitere Informationen

**56,90**

**150.1070** Reifenvulkanisier-Satz für KFZ, inklusive 100 mm Fäden

60 x 100 mm

70 g

9 mm

**OPTIONAL ZUM NACHKAUF**  
60 Stück  
**17,90**  
150.1072

- 
- 
- 
- 
- 
- 
-

**i** **1**  
Weitere Informationen

**89,90**

Aluminium-Radnabenschleifer-Satz Ø 150 mm, Innen-Ø 90 mm

100.5080

**OPTIONAL ZUM NACHKAUF**

**34,90**

100.5077

90 mm  
150 mm

**VORHER:** **NACHHER:**

**i** **4**  
Weitere Informationen

8 mm  
10 mm  
8 mm  
8 mm

**NEU**

OZ Spezial-Alu-Felgen-Stecknuss-Satz für mehrteilige OZ-Felgen

**14,90**

515.0795

**i** **3**  
Weitere Informationen

**39,90**

1/2" Spiral-Profil-Kraft-Stecknuss-Satz, 3-tlg, 17-21 mm

913.1270 17 - 19 - 21 mm

**i** **2**  
Weitere Informationen

19,5 mm  
18,5 mm  
21,5 mm  
20,5 mm

**+**

Spezial-Alu-Felgen-Kraft-Stecknuss-Satz für Ford, 18,5 / 19,5 / 20,5 / 21,5 mm

**27,90**

515.0895 18,5 - 19,5 - 20,5 - 21,5 mm

**i** **1**  
Weitere Informationen

**FÜR MERCEDES**

max. 75 Nm

**17,90**

1/2" Kraft-Torsions-Verlängerung, 75 Nm

515.1491

**i**  **10**  
 Weitere Informationen



**Radsicherungs-Demontageset**

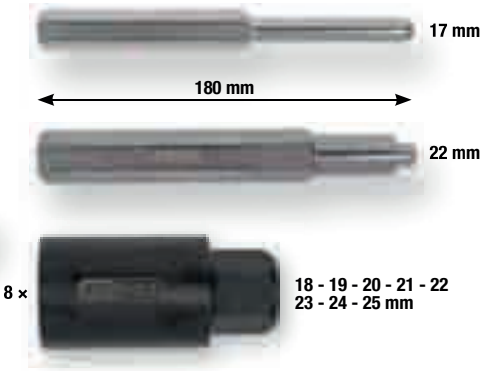

**59,90**

913.1480  18 - 19 - 20 - 21 - 22 - 23 - 24 - 25 mm



**i**  **15**  
 Weitere Informationen

**Felgenschloss-Demontage-Satz**



**139,90**



913.1430

**UNIVERSAL GENIAL - DIE PASSEN SICH AN JEDES PROFIL AN!**

# ROBUSTE 1/2" ALU-FELGEN KRAFT-STECKNUSS-SÄTZE

**1**

Weitere Informationen

**17,90**

515.1070 1/2" 17 - 19 - 21 mm

**2**

Weitere Informationen

**24,90**

515.0870 1/2" 15 - 17 - 19 - 21 - 22 mm

**3**

Weitere Informationen

**69,90**

515.0890 1/2" 15 - 17 - 19 - 21 - 22 - 23 - 24 mm  
7/8" 17 mm MS21

**4**

Weitere Informationen

**139,90**

**DER KOMPLETTE ALLESKÖNNER**

515.0885 1/2" 15 - 17 - 19 - 21 - 22 - 23 - 24 mm 7/8" 17 mm MS21 17 - 19 - 21 mm 18,5 / 19,5 - 20,5 / 21,5 - 17,5 / 22,5 mm

	515.1072 15 mm	515.1073 17 mm	515.1075 19 mm	515.1076 21 mm	515.1077 22 mm	515.1078 23 mm	515.1079 24 mm	515.1080 Tesla 7/8"	515.2055 Mercedes 17 mm	515.2060 Hyundai KIA MS21	913.1271 Spiralausdrehnuss 17 mm	913.1272 Spiralausdrehnuss 19 mm	913.1273 Spiralausdrehnuss 21 mm	515.0896 Ford 16,5 / 19,5 mm	515.0897 Ford 20,5 / 21,5 mm	515.0899 Ford 17,5 / 22,5 mm	515.1134 Kraft-Verlängerung, 75mm
<b>1</b>	X	✓	✓	✓	X	X	X	X	X	X	X	X	X	X	X	X	X
<b>2</b>	✓	✓	✓	✓	✓	X	X	X	X	X	X	X	X	X	X	X	X
<b>3</b>	✓	✓	✓	✓	✓	✓	✓	✓	✓	✓	X	X	X	X	X	X	X
<b>4</b>	✓	✓	✓	✓	✓	✓	✓	✓	✓	✓	✓	✓	✓	✓	✓	✓	✓

**i** **1**  
Weitere Informationen

aufladbar mit USB-C-Kabel (inklusive)

**16,90**

**350 Lumen**

**UV LED**

**Li-Ion**

mit Laserpointer

**LED COB Stripe Inspektionslampe**  
350 Lumen mit UV-Spot LED und Laserpointer

150.4400

max. 3 h  
3 h  
IP20  
+  
USB-C  
Hörgeräusch

**i** **1**  
Weitere Informationen

140 mm

**85 Lumen**

+ **2 x AA** ✓

**14,90**

25 m

**perfectLight**  
Taschenlampe 85 Lumen

150.4370

25 m  
max. 10 h  
IPX3  
+

**i** **1**  
Weitere Informationen

MAX. 350 Lumen

MAX. 100 Lumen

270°

**DAS MUST HAVE!**  
**FÜR WERKSTATT ODER OUTDOOR**

**14,90**

Li-Ion 3,7 V 1200 mAh

Sensorschalter

On/Off

Power Display

Bewegungssensor

XPE LED 2 Leuchtstufen

Größeneinstellung

COB LED 3 Leuchtstufen

95 g

max. 8 h  
4,5 h  
+

On/Off

Modi	COB 100%	COB 40%	COB rot	XPE 100%	XPE 40%
LED	270° 3 Watt COB LED			1 Watt High Power XPE LED	
40% 100%	350 LM	150 LM	=	100 LM	40 LM
⌚	3 h	6 h	8 h	4 h	8 h

**17,90**

Weitere Informationen

360°

250 Lumen

500 Lumen

USB

ON OFF

1200 mAh Lithium-Ionen Akku (inklusive)

180°

**oder**

3x AAA Batterien (nicht im Lieferumfang enthalten)

inklusive USB Power Bank Funktion

20 %	●
40 %	●●
60 %	●●●
80 %	●●●●
100 %	●●●●●

150.4510

max. 3 h

3 h

IP65

**19,90**

Weitere Informationen

130 Lumen

300 Lumen

USB-A OUT

USB-C IN

ON OFF

USB-A OUT

USB-C IN

integrierter Lithium-Ionen Akku 1.200 mAh

20 %	●
40 %	●●
60 %	●●●
80 %	●●●●
100 %	●●●●●

150.4505

max. 3 h

3 h

IP65

**16,50**

Weitere Informationen

60 Lumen

150 Lumen

Micro USB

ON OFF

360°

180°

20 %	●
40 %	●●
60 %	●●●
80 %	●●●●
100 %	●●●●●

150.4495

max. 3,5 h

2,5 h

IP20

**37,50**

Weitere Informationen

250 Lumen

550 Lumen

USB-A OUT

USB-C IN

ON OFF

250 Lumen

550 Lumen

20 %	●
40 %	●●
60 %	●●●
80 %	●●●●
100 %	●●●●●

150.4490

max. 3,5 h

3 h

IP65

**i**  **11**  
Weitere Informationen



**20-200 Nm**

**1/2"**

**500 mm**

**119,90**

125 mm

10 mm 13 mm 17 mm 19 mm 21 mm 24 mm

17 mm 19 mm 21 mm

516.2400 1/2" 10 - 13 - 17 - 19 - 21 - 24 mm

**i**  **8**  
Weitere Informationen

**FÜR REIFENWECHSEL IN REKORDZEIT**



**1600 Nm**

**1/2"**

**0 - 12 bar**

**2 x**

**Ø 150 mm**

**10 m**

**21 mm 19 mm 17 mm**

**NEU**

**119,90**

LL23-060\_EUR

**515.2100**

**Der führende Spezialist**  
**Kastner**  
Autoersatzteile - Zubehör - Werkstattengeräte

6020 Innsbruck	Trientlgasse 24	+43 (0)512/3312-0
6830 Rankweil	Gisingerstraße 2	+43 (0)5522/73614
8160 Weiz	Werksweg 106	+43 (0)3172/3975
8431 Gralla	Gewerbepark Süd 20	+43 (0)3452/84356
8572 Bärnbach	Dr. Niederdorferstr. 16a	+43 (0)3142/23630
8750 Judenburg	Gabelhoferstr. 8 - 10	+43 (0)3572/44040-0
2345 Brunn	Rennweg 77	+43 (0)2236/378900
8073 Feldkirchen b. Graz	Kalsdorfer Str. 41	+43 (0)316/244025

office@auto-kastner.at      www.auto-kastner.at

Mit Erscheinen dieses Prospektes verlieren alle vorangegangenen Preise hiermit ihre Gültigkeit. Verkauf nur an den Fachhandel. Druckfehler, Irrtümer und technische Änderungen vorbehalten. Alle Preise in EUR zzgl. MwSt. gelten bis 30.09.2024